



Thread milling cutters & gauges series

THREAD MILLS

Volume 5



INDEX

THREAD MILLING (Pre-drilled hole necessary)

Metric, metric fine

AT-1	PAGE 14
WX-PNC	PAGE 15
WXO-ST-PNC-3P	PAGE 16
WH-VM-PNC	PAGE 18

Unified

AT-1	PAGE 19
WX-PNC	PAGE 20
WH-VM-PNC	PAGE 21

G

AT-1	PAGE 22
WX-PNC	PAGE 23
WXO-ST-PNC-3P	PAGE 24

Rc

AT-1	PAGE 22
WX-PNC	PAGE 25

NPT

AT-1	PAGE 22
WX-PNC	PAGE 26

THREAD MILLING (No pre-drilled hole necessary)

Metric, metric fine

AT-2	PAGE 38
WH-EM-PNC	PAGE 47
WHO-EM-PNC	PAGE 47









U, UNJ, UNC, UNJC, UNF, UNJF

AT-2	PAGE 39
------------	---------

THREAD GAUGES

DCT (M, UNJF)	PAGE 50
E-DCT (MJ, UNJC, UNJF)	PAGE 56
DCT75 (MJ, U, RPT)	PAGE 58

THREAD MILLS OVERVIEW & WORK MATERIALS

									
Thread types		M, MF, U, UNJ, UNC, UNJC, UNF, UNJF, Rc, G, NPT	M, MF, UNJ, UNC, UNF, UNJC, UNJF, G, Rc, NPT	M, MF	M, MF, G	M, MF, U, UNJ, UNC, UNJC, UNF, UNJF	M, MF, U, UNJ, UNC, UNJC, UNF, UNJF	M, MF	M, MF
Oil hole		-	-	Y	-		Y (M10, M12)	-	Y
LxD		2xD	2xD	2xD	2,5xD	2xD	2xD, 2,5xD	2xD	2xD
Chamfer		-	-	-	-	-	Y	Y	Y
Threading without pre-drilled hole		-	-	-	-	-	Y	Y	Y
P	C:≤0,2%	⊙	○	○	○	○			
	C:0,25-0,45%	⊙	○	⊙	○	○			
	C:≥0,45%	⊙	○	⊙	○	○	○	○	○
	SCM	⊙	○	⊙	○	○	○	○	○
M	INOX	⊙	○	○	○	○			
K	GG	⊙	○	○	○	○			
	GGG	⊙	○	○	○	○			
N	Al	⊙	○	○	○	○			
	AC, ADC	⊙	○	○	○	○			
S	Ti		⊙		⊙	⊙	○	○	○
	Ni		⊙		⊙	⊙	○	○	○
H	25~35HRC	⊙	○	⊙	⊙	⊙	⊙	⊙	⊙
	35~45HRC	⊙	○	⊙	⊙	⊙	⊙	⊙	⊙
	45~52HRC						⊙	⊙	⊙
	52~62HRC						○	○	○

○ :Good ⊙ :Very Good

KEY FEATURES: AT-1

1 Unequal spacing with variable lead flute reduces vibration

2 Right-hand cut & left-hand helix geometry prevents bending

3 EgiAs coating with exceptional wear resistance and toughness

4 Ultra-Fine Grain Carbide with high wear resistance and toughness



AT-1: THE SECRET TO 1-PASS CUTTING

The secret to 1-pass cutting

Evolution from conventional 2-pass cutting to 1-pass cutting by preventing bending, reducing cutting time.

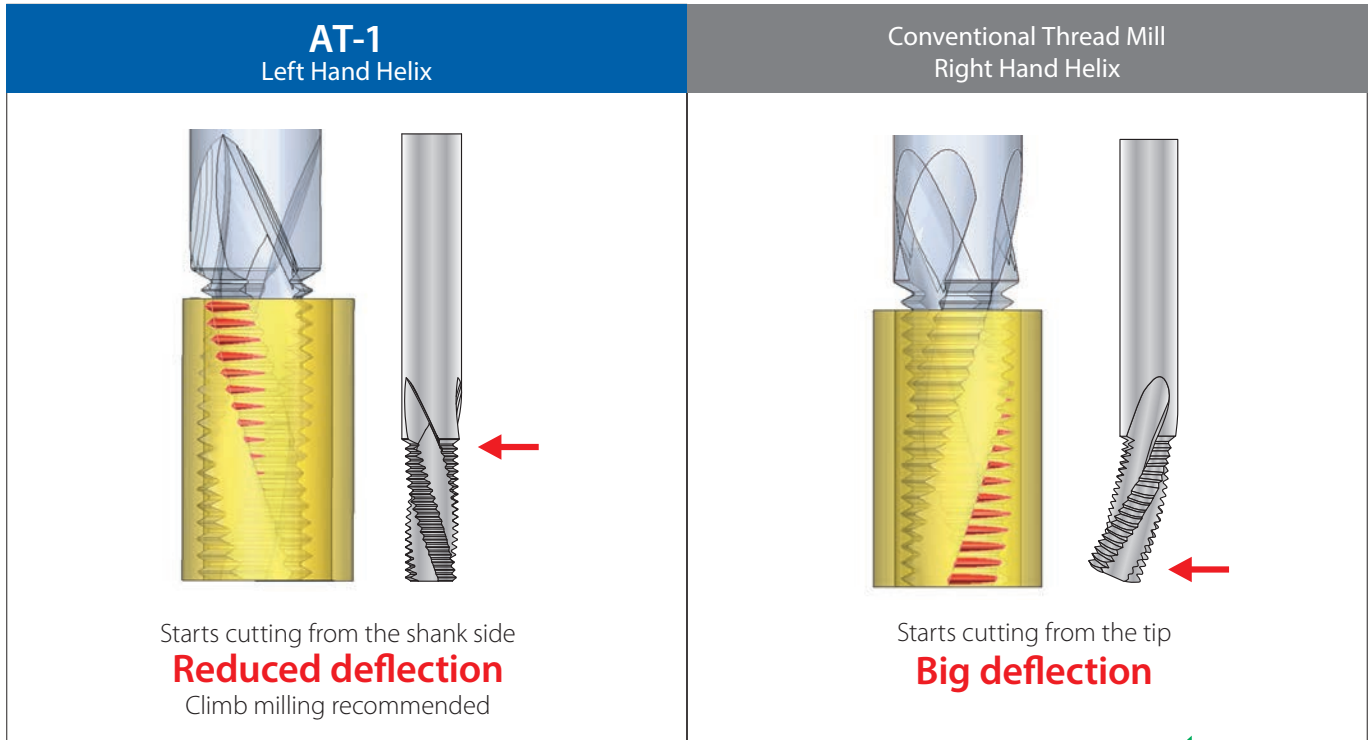

High quality internal threading

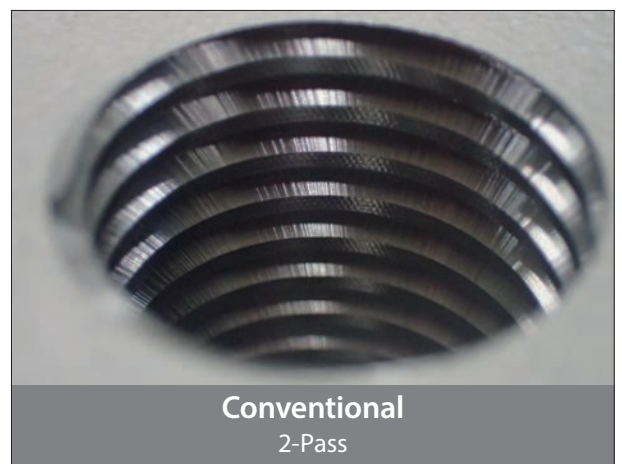
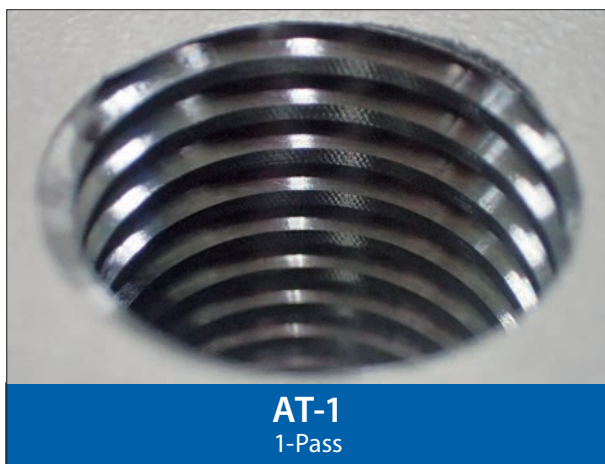

Size	Ø19,7 x 54 P3 6F
Work Material	SUS304
Cutting Speed	40 m/min (646min ⁻¹)
Feed	14 mm/min (0,02mm/t)
Internal Thread Size	M24 x 3
Tapping length	45 mm
Coolant	Water-Soluble
Machine	Horizontal Machining Center

SUPPORT TOOLS FOR YOUR THREAD MILLING NEEDS

1 RPRG

Use RPRG to reduce the workload. RPRG is the reference value of tool radius offset.

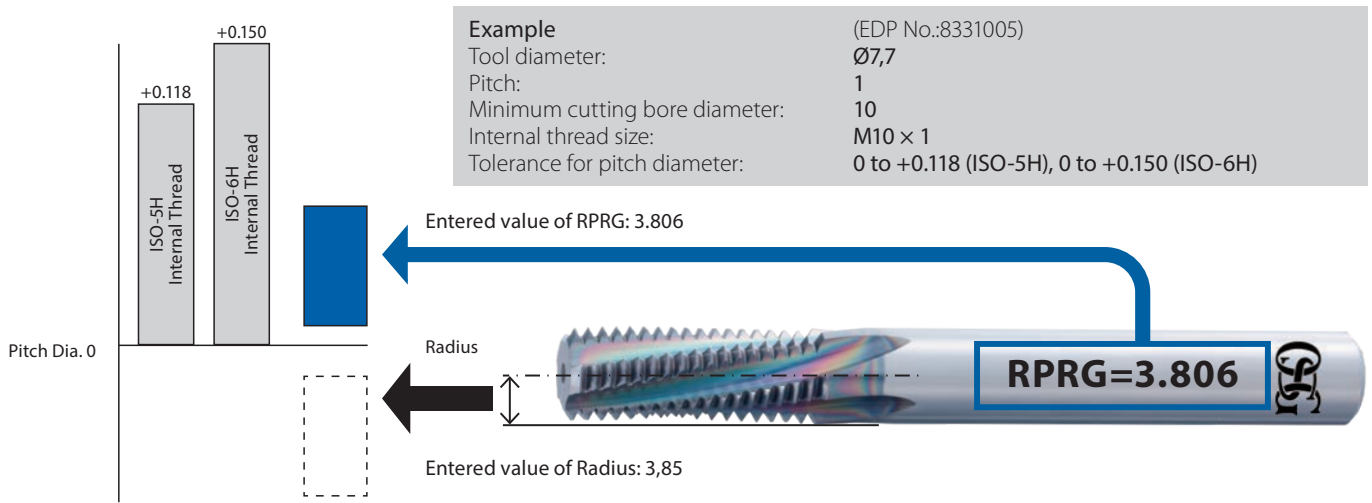

Notes

- RPRG are reference values. Optimal values for actual cutting depend on the machining environment. Determine optimal values after trial cutting.
- RPRG values are optimally established to achieve ISO:5H (formerly Grade 1) internal thread limits for metric threads and ANSI:3B internal thread limits for unified threads. RPRG values established for taper pipes (R/Rc) are effective when using the thread milling NC code generator software ThreadPro available on our website.
- For diameters of thread mills, RPRG values are calculated based on the minimum cutting bore diameter (the minimum cutting internal thread size of the tool diameter). To cut other diameters, it is necessary to use a smaller value than RPRG.

2 Revamped Thread Milling NC Code Generator Software "ThreadPro"

Create machining programs at ease with OSG's revamped NC code generator software ThreadPro.



3 Achieve stable tool life with the DCT for accurate diameter measurement

The internal thread effective diameter, which used to be difficult to determine, can now be measured with readable values.



Troubled by the following problems?

<p>Unsure of diameter correction value. Increase passes which results in longer setup time.</p>	<p>An incorrect diameter correction that result in a defective internal thread (gauge-out).</p>	<p>Unstable tool life</p>
---	---	---------------------------

Solved with the Diameter Correction Tool DCT



Simple measurement of pitch diameter by visual judgment

<p>Visibility of internal thread pitch diameter at entry enables the reduction of passes to minimize setup time significantly. Moreover, the DCT is able to measure pitch diameter smaller than the tolerance limit. The DCT can measure the pitch diameter of the female internal thread even if it does not fit into the Go-Gauge.</p>	<p>Visibility of internal thread pitch diameter at entry enables reliable diameter corrections. The DCT is useful for reducing defective workpieces.</p>	<p>Digitized measurement ensures consistent internal thread pitch diameters after tool changes. The same starting and finishing position ensures consistent and stable tool life.</p>
--	--	---



ADVANTAGES OF USING THREAD MILLS

A single tool cuts various sizes of diameters

A single tool can cut different threads such as M10 × 1.5, M12 × 1.5, and M16 × 1.5 if their pitch is the same.

Cuts large-diameter threads on low-power machine

The internal thread effective diameter, which used to be difficult to determine, can now be measured with readable values.

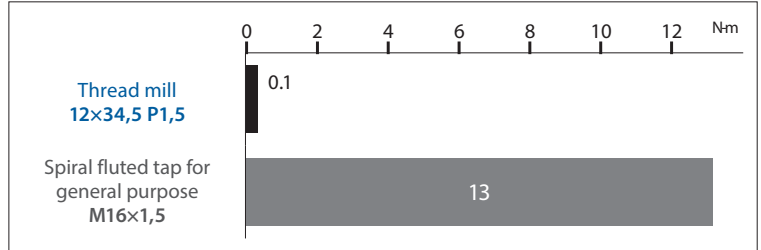

Smooth handling of chips to reduce problems

Thread mills break chips into small pieces and eject them smoothly, ensuring stable, problem-free thread cutting.

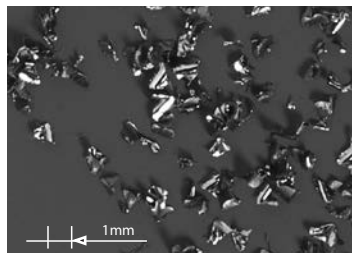

Thread mill chips
Material S45C

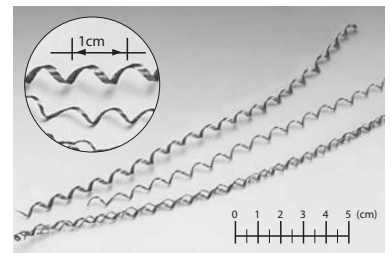

Spiral fluted tap chips

High-precision taper pipe threading (no stop marks)

Airtight threads by having no stop marks.

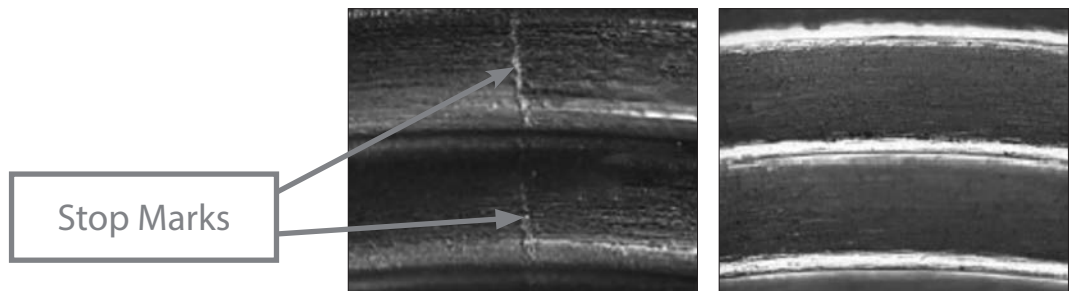

Thread cutting in drill holes with little allowance

Thread milling cuts the thread closer to the bottom of a hole than tapping, leaving only one incomplete crest of thread



CUTTING DATA

Effects of left-hand helix

Comparison of differences in internal thread pitch diameter at initial cutting stage.

Size	Ø7,7 × 22 P1 4F
Work Material	SCM440 (30 HRC)
Cutting Speed	100 m/min (4.136min ⁻¹)
Feed	380 mm/min (0,1mm/t)
Internal Thread Size	M10 x 1 mm
Drill Hole Size	Ø9 × 18 mm (Through)
Threading Length	15 mm
Machining Method	Climb milling 1-Pass
Coolant	Water-Soluble
Machine	Vertical Machining Center

The left-hand helix's small pitch diameter difference between the hole entry and inner hole allows a delay in gauge-out failure. Moreover, longer tool life can be achieved with "zero cutting" for correcting bending being eliminated.

	Hole Entry	Inner Hole Area	Dia. Difference
Right Hand Helix	+0,120 ~ +0,140	+0,040 ~ +0,060	0,060 ~ 0,100
Left Hand Helix	+0,120 ~ +0,140	+0,120 ~ +0,140	0 ~ +0,020

Pitch diameter measurement method : Step gauge

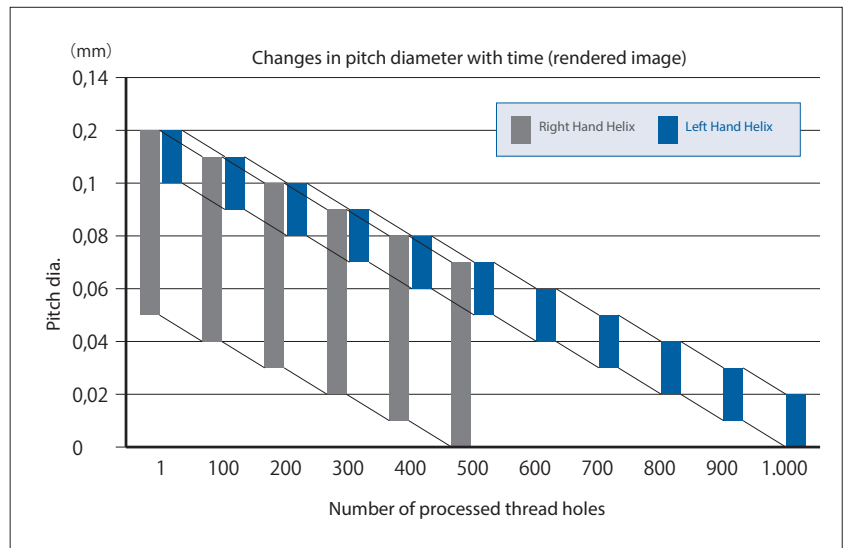

Effects of EgiAs coating

Cutting edge after threading 2.000 holes.

Size	Ø7,7 × 22 P1 4F
Work Material	SCM440 (30 HRC)
Cutting Speed	100 m/min (4.136min ⁻¹)
Feed	380 mm/min (0,1mm/t)
Internal Thread Size	M10 x 1 mm
Drill Hole Size	Ø9 × 18 mm (Through)
Threading Length	15 mm
Coolant	Water-Soluble
Machine	Vertical Machining Center

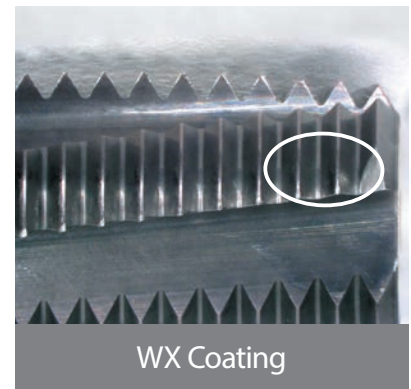
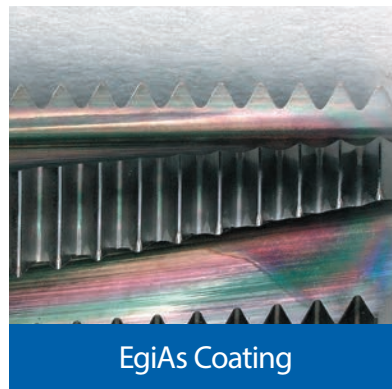

CUTTING DATA

Work materials ① to ② are machined under the conditions shown below.

Internal Thread Size	M10 x 1 mm
Drill Hole Size	Ø9 x 25 mm (Blind)
Threading Length	19 mm
Coolant	Water-Soluble
Machine	Vertical Machining Center

1. Internal thread pitch diameter difference between hole entry and inner hole area: 20µm or less

Eg: +0.080 step gauge passes completely, +0.100 step gauge stops less than or equal to one revolution.

2. Fastest cutting condition (including number of passes) while fulfilling the requirement of Condition 1.

① Machining SUS304

Tool	AT-1 Ø7,7x22 P1 4F	Competitor
Cutting Speed	120m/min (4.961min ⁻¹)	140m/min (5.122min ⁻¹)
Feed	228mm/min (0,05mm/t)	200mm/min (0,1mm/t)
Number of Passes	1-Pass	2-Passes
Cutting Time	2,26 sec	3,03 sec

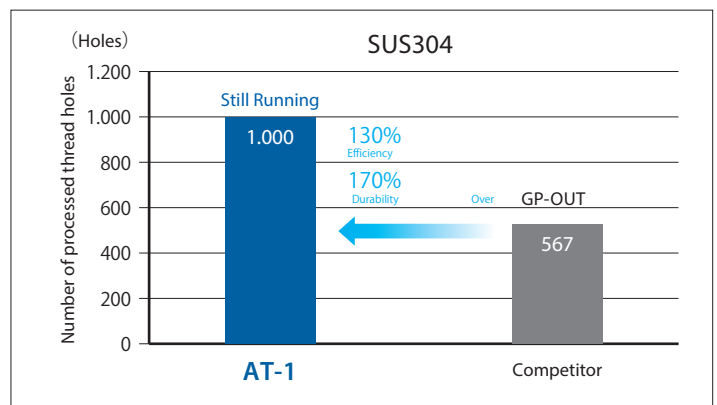

② Machining S50C

Tool	AT-1 Ø7,7x22 P1 4F	Competitor
Cutting Speed	160m/min (6.614min ⁻¹)	140m/min (5.122min ⁻¹)
Feed	122mm/min (0,02mm/t)	200mm/min (0,1mm/t)
Number of Passes	1-Pass	3-Passes
Cutting Time	4,28 sec	45,4 sec

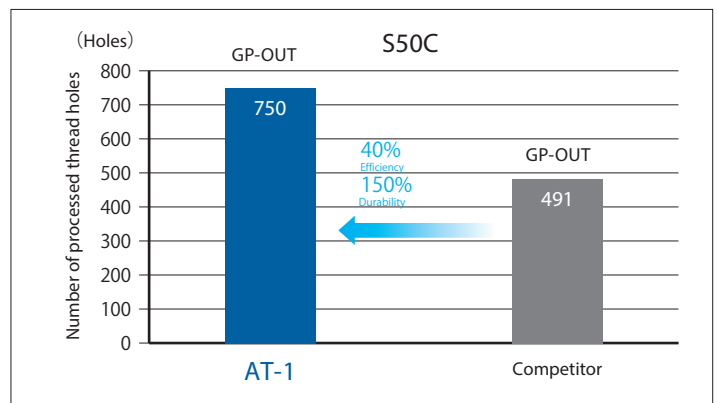

③ Machining SCM440

Tool	AT-1 Ø7,7x22 P1 4F	Competitor
Cutting Speed	80m/min (3.307min ⁻¹)	140m/min (5.122min ⁻¹)
Feed	30mm/min (0,01mm/t)	200mm/min (0,1mm/t)
Number of Passes	1-Pass	4-Passes
Cutting Time	17,12 sec	60,54 sec

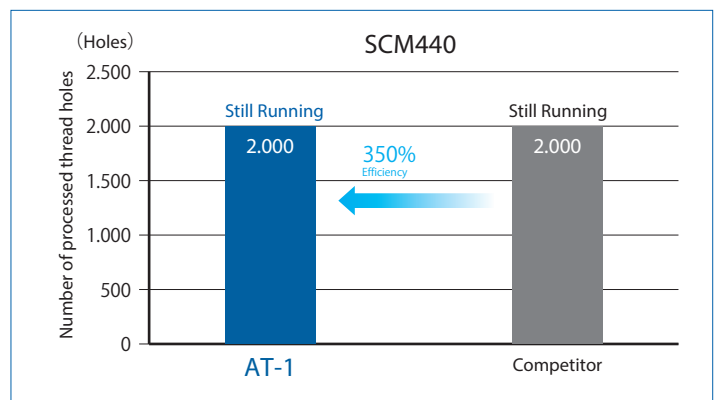

SUS304 durability test result

Tool	AT-1	WX-ST-PNC
Work Material	SUS304	
Cutting Speed	100m/min	120m/min
Feed	12,5mm/min	42mm/min
Internal Thread Size	M12 x 1,5	
Drill Hole Size	Ø10,5 x 25 mm (Through)	
Threading Length	22,5 mm	
Coolant	Water-Soluble	
Machine	Vertical Machining Center	
Number of Passes	1-Pass	2-Passes

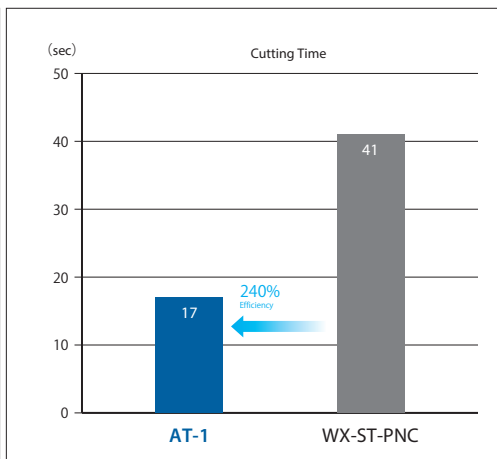
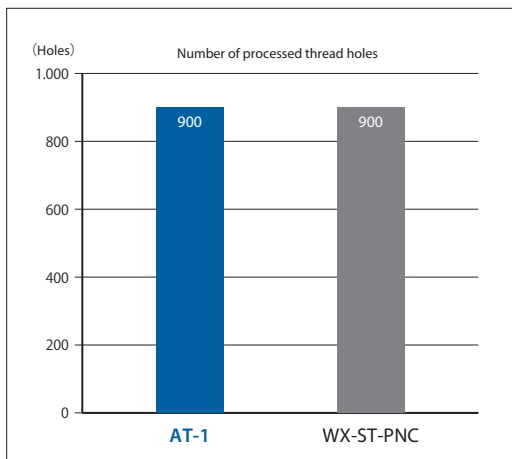

SUPPORT TOOLS FOR YOUR THREAD MILLING NEEDS

Reduce setup, machining time, and achieve stable tool life with these 3 support tools.

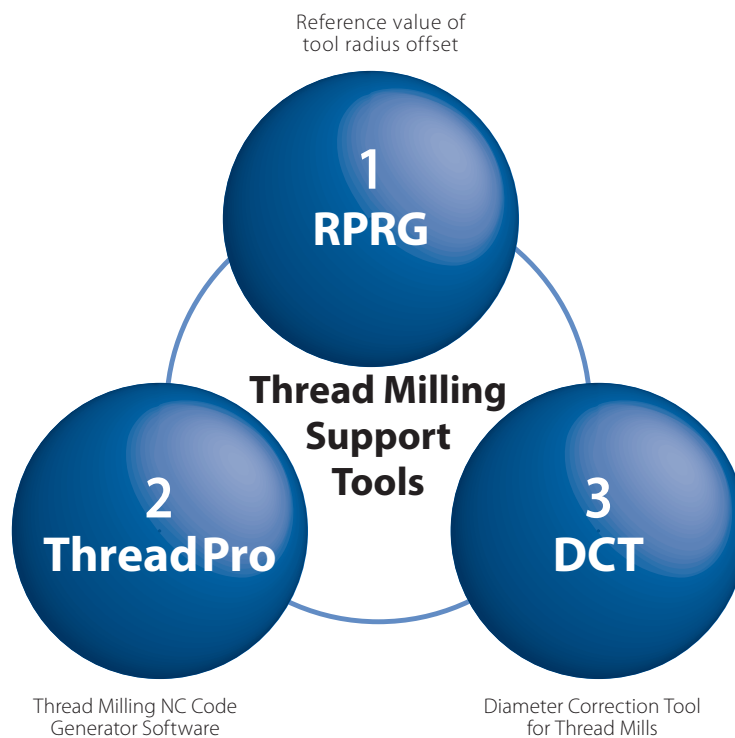

Machining Tips

Taps and drill combination

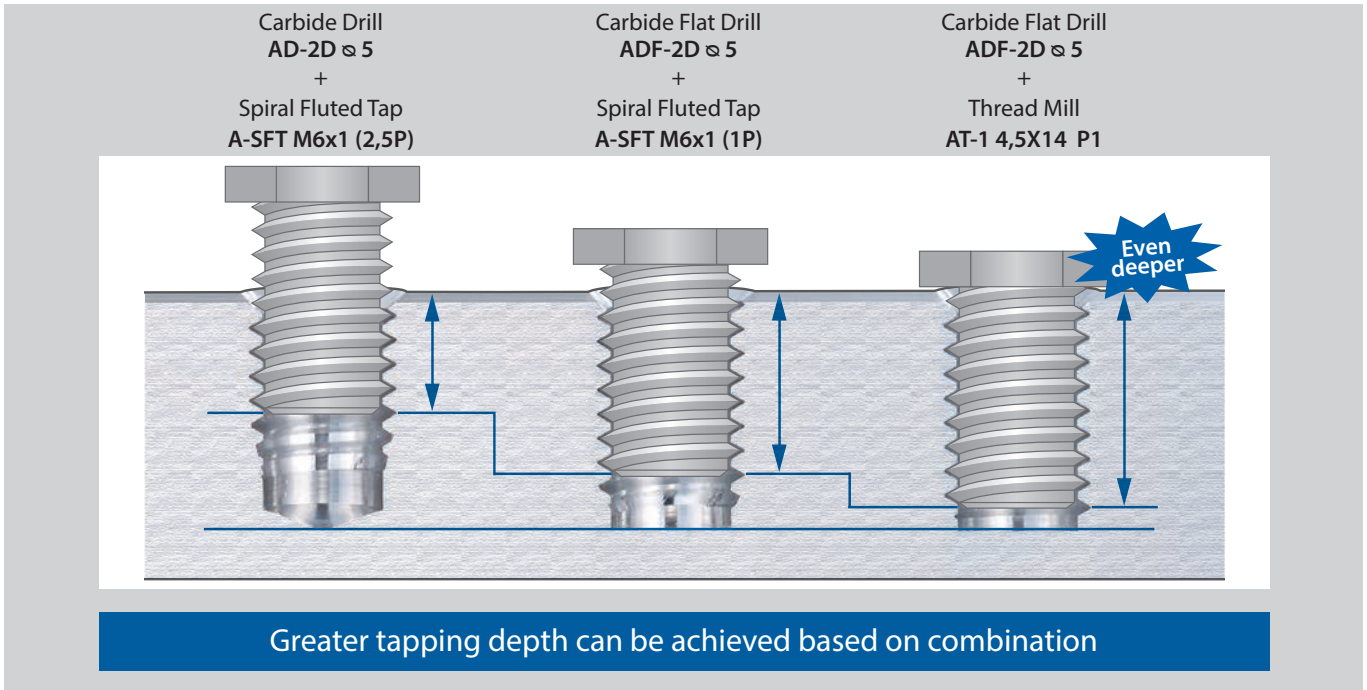

Threading | Thread milling

Solve them with the Diameter Correction Tool (DCT)

DCT

Simple measurement of pitch diameter by visual judgment



DCT75

Low-cost type
Measurement and calculation system

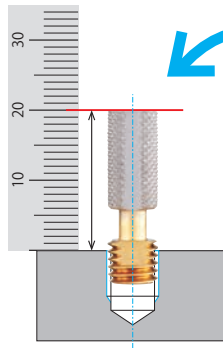

High-performance type
Digital display system

Eliminate measurement and calculation with the combination of a digital display.

Q&A FAQ ABOUT THREAD MILLING

Why internal thread cutting tools cannot be used to cut external threads?

Metric and unified threads have different thread profiles between internal and external threads. For these threads, internal thread cutting tools cannot be used to cut external threads because in their basic thread profiles, the crest and root shapes are not uniform. However, for pipe threads, which have uniform crests and roots, thread cutting tools can be shared for internal and external thread cutting.

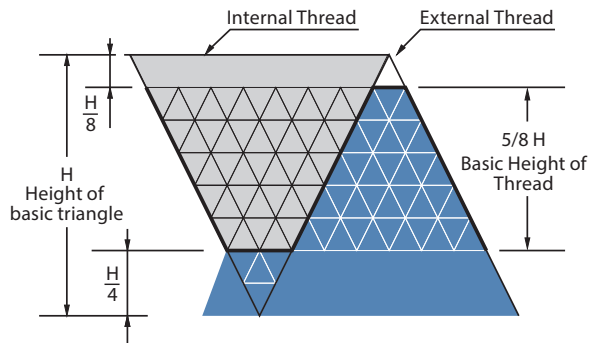

Compare the shapes of internal and external threads.

?	1/8 H	1/4 H
Height cut off from crest:	External Thread	Internal Thread
?	1/4 H	1/8 H
Height cut off at root:	External Thread	Internal Thread

Both threads have the same basic height of thread (5/8H). However, their shapes are different from each other.

Example of basic thread profile (metric thread)

What does the number "75" under "Fit %" mean, which is displayed on the data entry screen of ThreadPro?

It means to aim at the acceptable range of threads. Default values are 75% (larger side) for internal threads and 25% (smaller side) for external threads in light of their engagement. You can change these to your desired values.

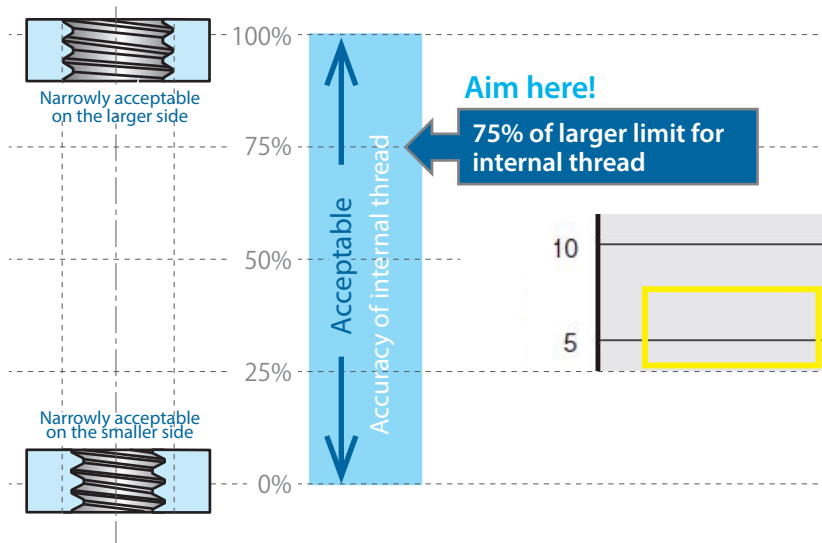

Is ThreadPro compatible with NC programs developed for custom-made thread mills ?

Yes, please consult our sales representatives.

AT-1

Threading | Thread milling | Metric & Metric Fine

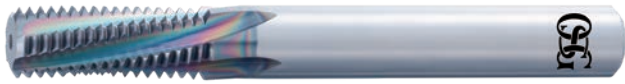

Type 1

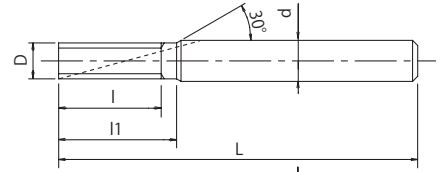

Type 2

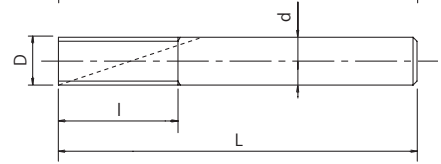

- First choice in quality and performance
- One pass thread mill
- EgiAs coating
- Milling for internal thread

P C: ≤0,2%	P C: 0,25-0,4%	P C: ≥0,45%	P SCM	M INOX	K GG	K GGG	N Al	N AC,ADC	H 25-35 HRC	H 35-45 HRC	m/min
80-160	80-160	80-160	60-120	60-120	80-160	60-120	80-160	100-300	80-200	80-200	

A
M
MF
MJ
CARBIDE
EgiAs
9°~13°
h6



EDP	Min. cutting bore \varnothing	P	D	L	l	l1	d	Z	Type	Price
8331000	M6	0,75	4,5	75	13,5	16	6	4	1	
8331001	M6	1	4,5	75	14	16	6	4	1	
8331002	M8	0,5	5,7	75	17	-	6	4	2	
8331003	M8	1	5,7	75	18	-	6	4	2	
8331004	M8	1,25	5,7	75	18,75	-	6	4	2	
8331005	M10	1	7,7	85	22	-	8	4	2	
8331006	M10	1,25	7,7	85	22,5	-	8	4	2	
8331007	M10	1,5	7,7	85	24	-	8	4	2	
8331008	M12	1	9,7	100	26	-	10	5	2	
8331009	M12	1,25	9,7	100	27,5	-	10	5	2	
8331010	M12	1,5	9,7	100	27	-	10	5	2	
8331011	M12	1,75	9,7	100	28	-	10	5	2	
8331012	M14	0,5	11,7	120	29	-	12	5	2	
8331013	M14	0,75	11,7	120	30	-	12	5	2	
8331014	M14	1	11,7	120	30	-	12	5	2	
8331015	M14	1,5	10,7	120	31,5	34,5	12	5	1	
8331016	M14	2	9,7	100	32	-	10	5	2	
8331017	M16	1	13,7	135	34	39	16	5	1	
8331018	M16	1,5	13,7	135	36	39	16	5	1	
8331019	M16	2	11,7	120	36	-	12	5	2	
8331020	M18	2,5	11,7	120	42,5	-	12	5	2	
8331021	M20	1,5	15,7	135	43,5	-	16	5	2	
8331022	M20	2,5	13,7	135	45	50	16	5	1	
8331023	M24	1,5	19,7	150	51	-	20	6	2	
8331024	M24	2	19,7	150	52	-	20	6	2	
8331025	M24	3	19,7	150	54	-	20	6	2	

WX-PNC

Threading | Thread milling | Metric & Metric Fine



Type 1

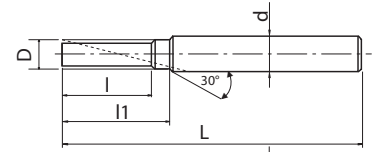

Type 2

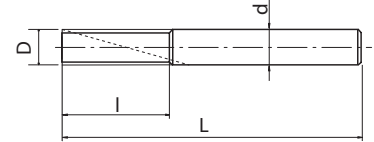

- Carbide thread milling cutter
- WX coating
- For all materials
- "ThreadPro" NC code generator software available

P ○ C < 0,2%	P ○ 0,25 < C < 0,4	P ○ C > 0,45%	P ○ SCM	M ○ INOX	K ○ GG	K ○ GGG	N ○ Al	N ○ AC,ADC	S ● Ti	S ● Ni	H ○ 25-35 HRC	H ○ 35-45 HRC	m/min
50-75	50-75	40-70	15-30	20-40	50-100	50-65	50-70	65-130	20-60	20-60	15-30	15-30	

M	MF	MJ	CARBIDE	WX	30°	h6
---	----	----	---------	----	-----	----



EDP	D	Minimum cutting bore Ø	P	L	l	l1	d	Z	Type	Price
3900001	4,5	M6	1	60	13	15	6	3	1	
3900011	6	M8	1	65	17	-	6	3	2	
3900012	6	M8	1,25	65	17,5	-	6	3	2	
3900021	7,5	M10	1	70	21	26	8	3	1	
1004470640	7,5	M10	1,25	70	21,3	26	8	3	1	
3900023	7,5	M10	1,5	70	22,5	26	8	3	1	
3900032	9,5	M12	1,25	85	26,3	28	10	4	1	
3900033	9,5	M12	1,5	85	25,5	28	10	4	1	
3900034	9,5	M12	1,75	85	26,3	28	10	4	1	
3900042	10	M14	1	85	29	-	10	4	2	
3900043	10	M14	1,5	85	30	-	10	4	2	
3900044	10	M14	2	85	30	-	10	4	2	
3900052	12	M16	1	95	33	-	12	4	2	
3900053	12	M16	1,5	95	34,5	-	12	4	2	
3900054	12	M16	2	95	34	-	12	4	2	
3900073	16	M20	1,5	105	42	-	16	4	2	
3900075	16	M20	2,5	105	42,5	-	16	4	2	
3900083	20	M27	1,5	120	49,5	-	20	5	2	
3900084	20	M27	2	120	50	-	20	5	2	
3900086	20	M27	3	120	51	-	20	5	2	

WXO-ST-PNC

Threading | Thread milling | Metric & Metric Fine

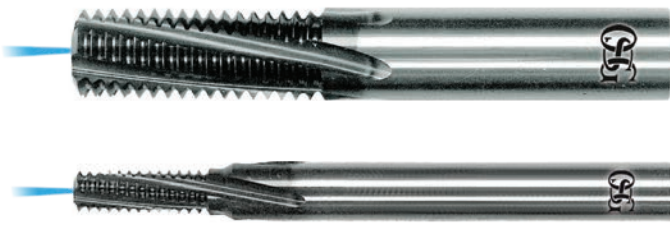

Type 1

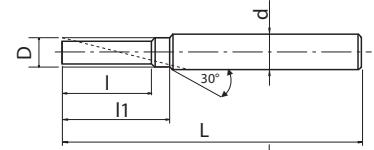

Type 2

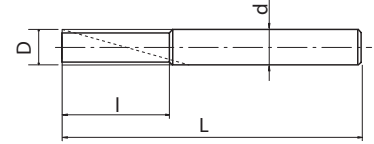

- Carbide thread milling cutter with Centre through coolant
- WX coating
- For all materials and hardened steels up to 45 HRC
- "ThreadPro" NC code generator software available

P ○ C < 0,2%	P ● 0,25 < C < 0,4	P ● C > 0,45%	P ● SCM	M ○ INOX	K ○ GG	K ○ GGG	N ○ Al	N ○ AC,ADC	H ● 25-35 HRC	H ● 35-45 HRC	m/min
80-120	80-120	80-120	80-120	40-80	50-100	50-65	50-70	65-130	60-100	60-100	

M	MF	MJ	CARBIDE	WX	11°		h6
---	----	----	---------	----	-----	--	----









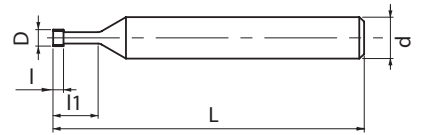





EDP	D	Minimum cutting bore Ø	P	L	l	l1	d	Z	Type	Price
8304700	4,5	M6	0,75	60	12,8	15	6	4	1	
8304701	4,5	M6	1	60	13	15	6	4	1	
8304710	6	M8	0,5	65	16,5	-	6	4	2	
8304711	6	M8	1	65	17	-	6	4	2	
8304712	6	M8	1,25	65	17,5	-	6	4	2	
8304721	7,5	M10	1	70	21	26	8	4	1	
8304723	7,5	M10	1,5	70	22,5	26	8	4	1	
8304732	9,5	M12	1,25	85	26,3	28	10	5	1	
8304733	9,5	M12	1,5	85	25,5	28	10	5	1	
8304734	9,5	M12	1,75	85	26,3	28	10	5	1	
8304740	10	M14	0,5	85	28,5	-	10	5	2	
8304741	10	M14	0,75	85	29,3	-	10	5	2	
8304742	10	M14	1	85	29	-	10	5	2	
8304743	10	M14	1,5	85	30	-	10	5	2	
8304744	10	M14	2	85	30	-	10	5	2	
8304752	12	M16	1	95	33	-	12	5	2	
8304753	12	M16	1,5	95	34	-	12	5	2	
8304754	12	M16	2	95	34	-	12	5	2	
8304773	16	M20	1,5	105	42	-	16	5	2	
8304775	16	M20	2,5	105	42,5	-	16	5	2	
8304783	20	M27	1,5	120	49,5	-	20	6	2	
8304784	20	M27	2	120	50	-	20	6	2	
8304786	20	M27	3	120	51	-	20	6	2	

WX-ST-PNC-3P

Threading | Thread milling | Metric & Metric Fine



- Carbide thread milling cutter with 3 crest thread length
- WXS coating
- For all materials and hardened steels up to 50 HRC
- "ThreadPro" NC code generator software available

P  C < 0,2%	P  0,25 < C < 0,4	P  C > 0,45%	P  SCM	M  INOX	K  GG	K  GGG	N  Al	N  AC,ADC	S  Ti	S  Ni	H  25-35 HRC	H  35-45 HRC	m/min
60-90	60-90	60-90	30-60	60-90	50-100	50-70	50-100	50-100	20-60	20-60	30-60	30-60	

M	MF	MJ	CARBIDE	SC D ≤ 1,3	WXS 1,5 ≤ D	11°	h6
----------	-----------	-----------	----------------	----------------------	-----------------------	------------	-----------



EDP	D	Minimum cutting bore Ø	P	L	I	l1	d	Z	Price
48216000	1,3	M1,8	0,35	40	1,05	5,4	3	3	
48216001	1,5	M2	0,4	40	1,2	6	3	3	
48216002	1,9	M2,5	0,45	40	1,35	7,5	6	3	
48216003	2,4	M3	0,5	60	1,5	9,5	6	3	
48216004	3,1	M4	0,7	60	2,1	12,7	6	3	
48216005	4	M5	0,8	60	2,4	15,8	6	3	
48216006	4,5	M6	1	60	3	20	6	4	
48216007	6	M8	1,25	60	3,75	24	6	4	
48216008	7,5	M10	1,5	80	4,5	33	8	4	
48216009	12	M16	1,5	100	4,5	50	12	5	
48216010	16	M20	1,5	100	4,5	50	16	5	
48216011	9,5	M12	1,75	80	5,25	38	10	5	
48216012	12	M16	2	100	6	50	12	5	
48216013	16	M20	2	100	6	50	16	5	
48216014	16	M20	2,5	100	7,5	50	16	5	

WH-VM-PNC

Threading | Thread milling | Metric & Metric Fine

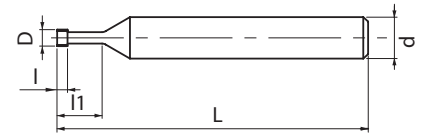

- Carbide thread milling cutter for small sizes
- WXS coating $1,5 \leq D$, SC coating $D_c \leq 1,3$
- For all materials and hardened steels up to 50 HRC
- "ThreadPro" NC code generator software available

P ○ C < 0,2%	P ○ 0,25 < C < 0,4	P ○ C > 0,45%	P ○ SCM	M ○ INOX	K ○ GG	K ○ GGG	N ○ Al	N ○ AC,ADC	S ○ Ti	S ○ Ni	H ○ 25-35 HRC	H ○ 35-45 HRC
60-90	60-90	60-90	30-60	60-90	50-100	50-70	50-100	50-100	20-60	20-60	30-60	30-60

m/min

M	MF	MJ	CARBIDE	SC D ≤ 1,3	WXS 1,5 ≤ D	11°	h6
---	----	----	---------	---------------	----------------	-----	----



EDP	D	Minimum cutting bore Ø	Thread per flute	P	L	I	l1	d	Z	Price
3900495	0,72	M1	1	0,25	40	0,25	2,75	3	3	
3900496	0,92	M1,2	1	0,25	40	0,25	3,25	3	3	
3900497	1,05	M1,4	1	0,3	40	0,3	3,8	3	3	
3900498	1,2	M1,6	1	0,35	40	0,35	4,35	3	3	
3900499	1,3	M1,7 ~ M1,8	1	0,35	40	0,35	4,85	3	3	
3900500	1,5	M2	3	0,4	40	1,2	4,4	6	3	
3900501	1,9	M2,5 ~ M2,6	3	0,45	40	1,4	5,6	6	3	
3900502	2,4	M3	3	0,5	40	1,5	6,5	6	3	
3900503	3,1	M4	3	0,7	40	2,1	8,7	6	3	
3900504	4	M5	3	0,8	40	2,4	10,8	6	3	

Threading | Thread milling

Metric & Metric Fine

AT-1

Threading | Thread milling | U UNJ UNC UNJC UNF UNJF



Type 1

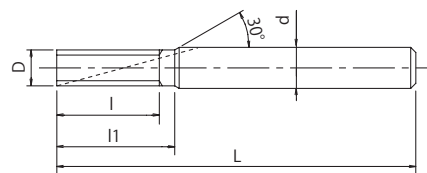

Type 2

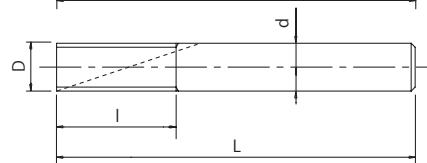

- First choice in quality and performance
- One pass thread mill
- EgiAs coating
- Milling for internal thread

P C: ≤0,2%	P C: 0,25-0,4%	P C: ≥0,45%	P SCM	M INOX	K GG	K GGG	N AI	N AC,ADC	H 25-35 HRC	H 35-45 HRC	m/min
80-160	80-160	80-160	60-120	60-120	80-160	60-120	80-160	100-300	80-200	80-200	

A	U	UNJ	UNC	UNJC	UNF	UNJF	CARBIDE	EgiAs	9°~13°	h6	page 24
----------	----------	------------	------------	-------------	------------	-------------	----------------	--------------	---------------	-----------	---------

EDP	Min. cutting bore \varnothing	TPI	D	L	I	I1	d	Z	Type	Price
8331026	1/4	20	4,55	75	15,24	17,78	6	4	1	
8331027	1/4	28	4,55	75	15,42	17,23	6	4	1	
8331028	5/16	18	5,7	75	19,75	-	6	4	2	
8331029	5/16	24	5,7	75	19,04	-	6	4	2	
8331030	5/16	32	5,7	75	17,47	-	6	4	2	
8331031	3/8	16	6,7	85	22,23	25,41	8	4	1	
8331032	3/8	24	6,7	85	22,22	24,33	8	4	1	
8331033	3/8	32	6,7	85	20,64	22,23	8	4	1	
8331034	7/16	14	7,7	85	27,21	-	8	4	2	
8331035	7/16	20	7,7	85	25,40	-	8	4	2	
8331036	1/2	13	8,7	100	29,31	33,22	10	5	1	
8331037	1/2	20	8,7	100	27,94	30,48	10	5	1	
8331038	1/2	28	8,7	100	28,12	29,93	10	5	1	
8331039	9/16	12	9,7	100	33,87	-	10	5	2	
8331040	9/16	18	9,7	100	32,45	-	10	5	2	
8331041	5/8	11	10,7	120	36,94	41,56	12	5	1	
8331042	5/8	18	10,7	120	35,28	38,10	12	5	1	
8331043	5/8	24	10,7	120	34,91	37,03	12	5	1	
8331044	3/4	10	11,7	120	43,18	-	12	5	2	
8331045	3/4	16	11,7	120	41,29	-	12	5	2	
8331046	7/8	9	13,7	135	50,80	56,44	16	5	1	
8331047	7/8	14	13,7	135	48,98	52,61	16	5	1	
8331048	1	8	18,7	150	57,15	63,50	20	6	1	
8331049	1	20	18,7	150	53,34	55,88	20	6	1	

Threading | Thread milling

U UNJ UNC UNJC UNF UNJF

WX-PNC

Threading | Thread milling | UNC, UNF, UNJC & UNJF



Type 1

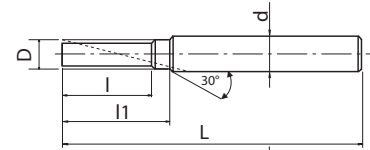

Type 2

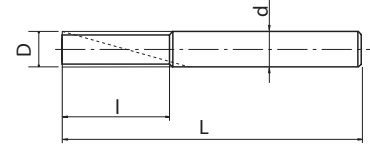

- Carbide thread milling cutter
- WX coating
- For all materials
- "ThreadPro" NC code generator software available

P ○ C < 0,2%	P ○ 0,25 < C < 0,4	P ○ C > 0,45%	P ○ SCM	M ○ INOX	K ○ GG	K ○ GGG	N ○ Al	N ○ AC,ADC	S ● Ti	S ● Ni	H ○ 25-35 HRC	H ○ 35-45 HRC	m/min
50-75	50-75	40-70	15-30	20-40	50-100	50-65	50-70	65-130	20-60	20-60	15-30	15-30	

UNC
UNF
UNJC
UNJF
CARBIDE
WX
30°
h6
page 25

EDP	D	Minimum cutting bore Ø	P	L	l	l1	d	Z	Type	Price
3900350	4,55	1/4	20	60	10,2	11,4	6	3	1	
3900351	4,55	1/4	28	60	10	10,9	6	3	1	
3900355	6,2	5/16	18	65	12,7	14,1	8	3	1	
3900356	6,2	5/16	24	65	12,7	14,1	8	3	1	
3900360	7,6	3/8	16	65	14,3	-	8	3	2	
3900361	7,6	3/8	24	65	14,8	-	8	3	2	
3900365	8,8	7/16	14	75	18,1	19,9	10	3	1	
3900366	8,8	7/16	20	75	17,8	19,1	10	3	1	
3900370	9,4	1/2	13	75	19,5	21,5	10	4	1	
3900371	9,4	1/2	20	75	19,1	20,4	10	4	1	
3900375	10,9	9/16	12	85	23,3	25,4	12	4	1	
3900380	11,4	9/16	18	85	22,6	24	12	4	1	
3900390	18,9	7/8	12	110	33,9	36	20	4	1	

WH-VM-PNC

Threading | Thread milling | U UNJ UNF UNJF

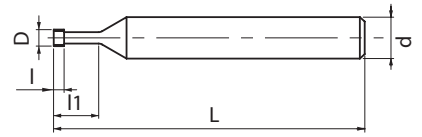

- Carbide thread milling cutter for small sizes
- SC coating $D_c \leq 1,3$
- For all materials and hardened steels up to 50 HRC
- "ThreadPro" NC code generator software available

P ○ C < 0,2%	P ○ 0,25 < C < 0,4	P ○ C > 0,45%	P ○ SCM	M ○ INOX	K ○ GG	K ○ GGG	N ○ Al	N ○ AC,ADC	S ● Ti	S ● Ni	H ● 25-35 HRC	H ● 35-45 HRC	m/min
60-90	60-90	60-90	30-60	60-90	50-100	50-70	50-100	50-100	20-60	20-60	30-60	30-60	

U **UNJ** **UNF** **UNJF** **CARBIDE** **WXS** **11°** **h6**

page 24

EDP	D	Minimum cutting bore Ø	Thread per flute	P	L	I	l1	d	Z	Price
3900513	3,2	N°8	3	32	40	2,4	9,1	6	3	

Threading | Thread milling

U UNJ UNF UNJF

AT-1 NEW

Threading | Thread milling | R (PT), Rc (PT), Rp (PS), G (PF), NPT



Type 1

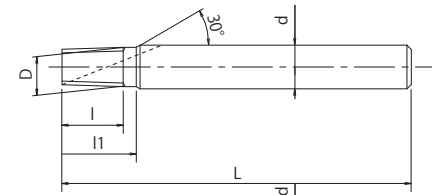

Type 2

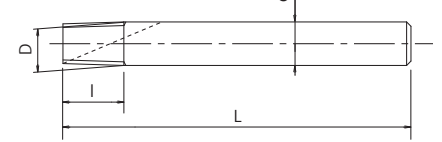

Type 3

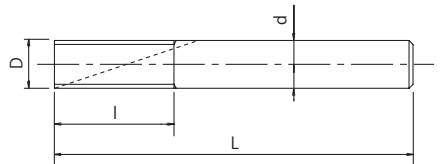

- First choice in quality and performance
- One pass thread mill
- EgiAs coating
- Milling for internal thread

P C: ≤0,2%	P C: 0,25-0,4%	P C: ≥0,45%	P SCM	M INOX	K GG	K GGG	N Al	N AC,ADC	H 25-35 HRC	H 35-45 HRC	m/min
80-160	80-160	80-160	60-120	60-120	80-160	60-120	80-160	100-300	80-200	80-200	

A **Rc (PT)** **R (PT)** **CARBIDE** **EgiAs** **9°~13°** **h6**



EDP	Range of thread size	TPI	D	L	I	l1	d	Z	Type	Price
8331075	1/16 1/8	28	5,67	60	9,1	-	6	4	2	
8331076	1/8	28	7,67	60	9,1	12,7	8	4	1	
8331077	1/4 3/8	19	9,67	75	14,7	-	10	5	2	
8331078	3/8	19	11,67	85	14,7	20	12	5	1	
8331079	1/2 3/4	14	11,67	85	20	-	12	5	2	
8331080	3/4	14	15,67	95	20	-	16	5	2	
8331081	1 ~ 2	11	19,67	105	27,7	-	20	6	2	

A **Rp (PS)** **G (PF)** **CARBIDE** **EgiAs** **9°~13°** **h6**

EDP	Range of thread size	TPI	D	L	I	l1	d	Z	Type	Price
8331082	1/16 1/8	28	5,67	60	11,8	-	6	4	3	
8331083	1/8	28	7,67	65	14,5	-	8	4	3	
8331084	1/4 3/8	19	9,67	80	20,1	-	10	5	3	
8331085	3/8	19	11,67	100	25,4	-	12	5	3	
8331086	1/2 7/8	14	11,67	100	32,7	-	12	5	3	
8331087	3/4 7/8	14	15,67	115	39,9	-	16	5	3	
8331088	1 ~ 2	11	19,67	130	50,8	-	20	6	3	

A **NPT** **CARBIDE** **EgiAs** **9°~13°** **h6**

EDP	Range of thread size	TPI	D	L	I	l1	d	Z	Type	Price
8331089	1/16 1/8	27	5,67	60	10,35	-	6	4	2	
8331090	1/8	27	7,67	60	10,35	-	8	4	2	
8331091	1/4 3/8	18	9,67	75	15,52	-	10	5	2	
8331092	3/8	18	11,67	85	15,52	-	12	5	2	
8331093	1/2 3/4	14	15,67	95	19,96	-	16	5	2	
8331094	1 ~ 2	11,5	18,72	105	24,3	28,7	20	6	1	

WX-PNC

Threading | Thread milling | RC



Type 1

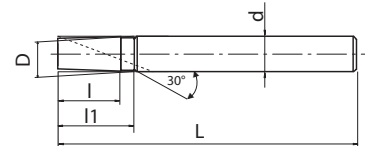

Type 2

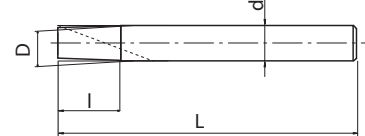

- Carbide thread milling cutter
- WX coating
- For all materials
- "ThreadPro" NC code generator software available

P ○ C < 0,2%	P ○ 0,25 < C < 0,4	P ○ C > 0,45%	P ○ SCM	M ○ INOX	K ○ GG	K ○ GGG	N ○ Al	N ○ AC,ADC	S ● Ti	S ● Ni	H ○ 25-35 HRC	H ○ 35-45 HRC	m/min
50-75	50-75	40-70	15-30	20-40	50-100	50-65	50-70	65-130	20-60	20-60	15-30	15-30	

Rc (PT)	CARBIDE	WX	30°	h6
----------------	----------------	-----------	------------	-----------



EDP	D	Minimum cutting bore Ø	P	L	I	l1	d	Z	Type	Price
3900201	7,5	1/8	28	60	9,1	12,7	8	3	1	
3900211	10	1/4~3/8	19	75	14,7	-	10	4	2	
3900214	12	1/2~3/4	14	85	20	-	12	4	2	
3900218	20	1~2	11	95	27,7	-	20	5	2	

CUTTING CONDITIONS

Threading | Thread mills | Cutting conditions

AT-1

Work Material		Vc (m/min)	F (mm/tooth)
Low Tensile Strength Steel	C~0,25%	80~160	0,01~0,05
Medium Tensile Strength Steel	C~0,25% ~ 0,45%	80~160	0,01~0,05
High Tensile Strength Steel	C0,45%~	80~160	0,01~0,05
Alloy Steel	SCM	60~120	0,01~0,05
Hardened Steel	25~45 HRC	80~200	0,01~0,05
	45~55 HRC	-	-
	50~60 HRC	-	-
Stainless Steel	SUS	60~120	0,01~0,05
Tool Steel	SKD	-	-
Cast Steel	SC	60~120	0,01~0,05
Cast Iron	FC	80~160	0,01~0,05
Ductile Cast Iron	FCD	60~120	0,01~0,05
Copper	Cu	80~160	0,03~0,1
Brass	Bs	80~160	0,03~0,1
Brass Casting	BsC	80~160	0,03~0,1
Bronze	PB	80~160	0,03~0,1
Aluminium Rolled Steel	AL	80~160	0,03~0,1
Aluminium Alloy Casting	AC, ADC	100~300	0,05~0,2
Magnesium Alloy Casting	MC	100~300	0,05~0,2
Zinc Alloy Casting	ZDC	100~300	0,05~0,2
Titanium Alloys	Ti-6AL-4V	-	-
Nickel Alloys	Inconel®	-	-
Thermosetting plastic	-	80~160	0,03~0,1
Thermoplastic	-	80~160	0,03~0,1

1. The indicated speeds and feeds are for water-soluble oil.
2. Water-soluble oil is not suitable for tapping magnesium alloy.
3. Please adjust the cutting conditions depending on the rigidity of machine, tool holders, and workpiece clamping.
4. If the tapping length is long, or when machining a large-pitch thread, select a smaller feed rate and separate the machining process into a few segments.
5. If a machined parallel internal thread is tapered and prevents the go-gauge from going through, add a zero cut (finish machining).

Formula for calculating the feed rate of thread mill

$$V_f = \frac{f \times z \times n \times (D_m \pm D_c)}{D_m} \text{ (mm/min)}$$

v_f	Feed (mm/min)	z	Number of Flutes
D_m	Actual Dia. (mm)	f	Feed (mm/t)
D_c	Tool Dia. (mm)	n	Speed (min ⁻¹)

Note Internal: - External: +

For the arc cutting process of machining external and internal threads, the feed rate at the tool center can be obtained by multiplying the linear cut feed rate with a coefficient. The formulas for calculating coefficients vary between external and internal thread cutting. The formula listed left are for calculating the tool feed rate during arc-cutting, including calculating the coefficients to be used for multiplication with the linear-cut feed rate.

CUTTING CONDITIONS

Threading | Thread mills | Cutting conditions

WXO-ST-PNC

Work Material		Vc (m/min)	F (mm/tooth)
Low Tensile Strength Steel	C~0,25%	80~120	0,04~0,1
Medium Tensile Strength Steel	C~0,25% ~ 0,45%	80~120	0,04~0,1
High Tensile Strength Steel	C0,45%~	80~120	0,04~0,1
Alloy Steel	SCM	80~120	0,02~0,08
Hardened Steel	25~45 HRC	60~100	0,02~0,08
	45~55 HRC	-	-
	50~60 HRC	-	-
Stainless Steel	SUS	40~80	0,02~0,06
Tool Steel	SKD	-	-
Cast Steel	SC	40~65	0,02~0,09
Cast Iron	FC	50~100	0,03~0,1
Ductile Cast Iron	FCD	50~65	0,03~0,1
Copper	Cu	65~130	0,03~0,1
Brass	Bs	65~130	0,03~0,1
Brass Casting	BsC	65~130	0,03~0,1
Bronze	PB	65~130	0,03~0,1
Aluminium Rolled Steel	AL	50~70	0,03~0,1
Aluminium Alloy Casting	AC, ADC	65~130	0,03~0,1
Magnesium Alloy Casting	MC	65~130	0,03~0,1
Zinc Alloy Casting	ZDC	65~130	0,03~0,1
Titanium Alloys	Ti-6AL-4V	20~60	0,02~0,06
Nickel Alloys	Inconel®	20~60	0,01~0,03
Thermosetting plastic	-	65~130	0,03~0,13
Thermoplastic	-	65~130	0,03~0,13

Threading | Thread milling

Cutting conditions

WX-PNC

Work Material		Vc (m/min)	F (mm/tooth)
Low Tensile Strength Steel	C~0,25%	50~75	0,01~0,11
Medium Tensile Strength Steel	C~0,25% ~ 0,45%	40~70	0,01~0,11
High Tensile Strength Steel	C0,45%~	40~70	0,01~0,01
Alloy Steel	SCM	15~30	0,01~0,03
Hardened Steel	25~45 HRC	15~30	0,01~0,03
	45~55 HRC	-	-
	50~60 HRC	-	-
Stainless Steel	SUS	20~40	0,01~0,06
Tool Steel	SKD	-	-
Cast Steel	SC	40~65	0,02~0,09
Cast Iron	FC	50~100	0,03~0,1
Ductile Cast Iron	FCD	50~65	0,03~0,1
Copper	Cu	65~130	0,03~0,1
Brass	Bs	65~130	0,03~0,1
Brass Casting	BsC	65~130	0,03~0,1
Bronze	PB	65~130	0,03~0,1
Aluminium Rolled Steel	AL	50~70	0,03~0,1
Aluminium Alloy Casting	AC, ADC	65~130	0,03~0,1
Magnesium Alloy Casting	MC	65~130	0,03~0,1
Zinc Alloy Casting	ZDC	65~130	0,03~0,1
Titanium Alloys	Ti-6AL-4V	20~60	0,02~0,06
Nickel Alloys	Inconel®	20~60	0,01~0,03
Thermosetting plastic	-	65~130	0,03~0,13
Thermoplastic	-	65~130	0,03~0,13

CUTTING CONDITIONS

Threading | Thread mills | Cutting conditions

WH-VM-PNC/WX-ST-PNC-3P



Work Material		Vc (m/min)	F (mm/tooth)
Low Tensile Strength Steel	C~0,25%	60~90	0,02~0,08
Medium Tensile Strength Steel	C~0,25% ~ 0,45%	60~90	0,02~0,08
High Tensile Strength Steel	C0,45%~	60~90	0,02~0,08
Alloy Steel	SCM	30~60	0,01~0,03
Hardened Steel	25~45 HRC	30~60	0,01~0,03
	45~55 HRC	30~60	0,01~0,03
	50~60 HRC	-	-
Stainless Steel	SUS	60~90	0,02~0,08
Tool Steel	SKD	-	-
Cast Steel	SC	40~65	0,02~0,09
Cast Iron	FC	50~100	0,03~0,1
Ductile Cast Iron	FCD	50~70	0,03~0,1
Copper	Cu	-	-
Brass	Bs	-	-
Brass Casting	BsC	50~100	0,02~0,06
Bronze	PB	50~100	0,02~0,06
Aluminium Rolled Steel	AL	50~100	0,02~0,06
Aluminium Alloy Casting	AC, ADC	50~100	0,02~0,06
Magnesium Alloy Casting	MC	50~100	0,02~0,06
Zinc Alloy Casting	ZDC	50~100	0,02~0,06
Titanium Alloys	Ti-6AL-4V	20~60	0,01~0,03
Nickel Alloys	Inconel®	20~60	0,01~0,03
Thermosetting plastic	-	50~100	0,02~0,06
Thermoplastic	-	50~100	0,02~0,06



Machining Technique

OSG's Thread Mills are developed for thread milling on a 3-Axis CNC controlled machine tool. Threads are produced by advancing one pitch feed per revolution in the axial direction, utilizing the planet-like rotation and revolution movements of the tool. Internal/external and right/left hand threads can all be produced with this one tool by simply changing the direction of rotation and/or feed

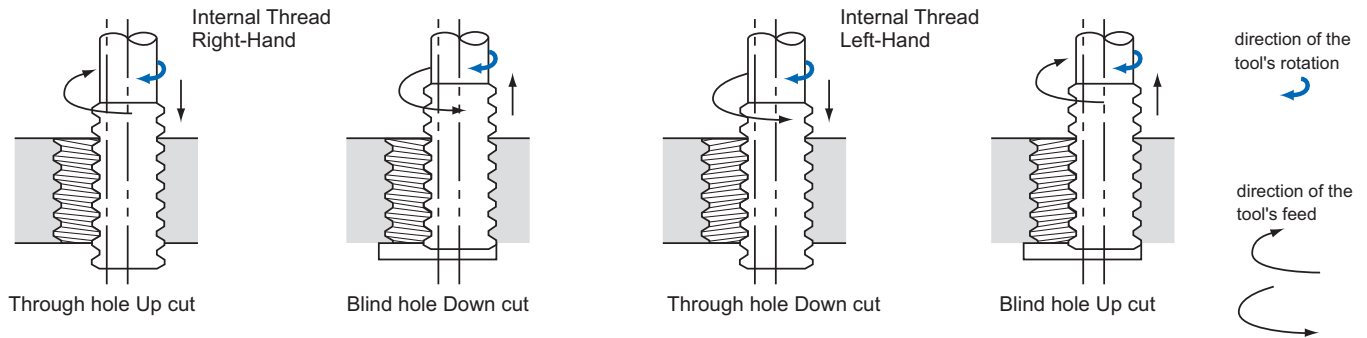

Threading | Thread milling

Threading Process

- 1-2 Move to edge (maintain clearance)
- 2-3 Cut with helical milling
- 3-4 Mill the circumference of the circle
- 4-5 Pull away from the edge
- 5-6 Remove tool

The transition between the start and finish of the milling operation must be smooth and the appropriate amount of feed is essential for minimizing milling resistance. There are many different methods for using this tool, but our research has shown that this technique provides the most precise and efficient operation.

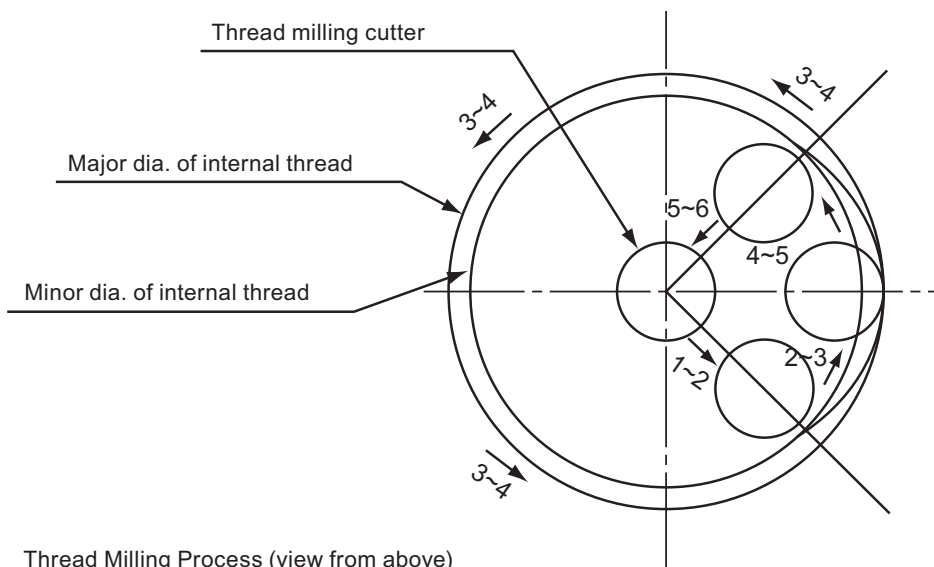

Technical Process

Machining small diameter internal threads with stainless steel

Tool	WH-VM-PNC 0,72 P0,25	Competitor	Description	Tool Life	
	SUS304			100	200
Work Material	SUS304		WH-VM-PNC	212 Holes → Gauge-Out	
Cutting Speed	80m/min (35.367min ⁻¹)			235 Holes → Gauge-Out	
Feed	594mm/min (0.02mm/t)		Competitor	122 Holes → Gauge-Out	
Internal Thread Size	M1x0.25			198 Holes → Gauge-Out	
Drill Hole Size	φ0.78x2.5mm (Blind)				
Tapping Length	2mm (2D) (Blind)				
Machining Method	Up Cut 2 passes				
Coolant	Water Soluble				
Machine	(HSK-E25) Vertical Machining Center				

The WH-VM-PNC was able to perform stably with water-soluble coolant in stainless steel, a difficult process for cut taps. It was able to achieve long tool life and perform stably when tapping M1 threads. When processing threads with limited tap drill hole depth allowance for tap drill holes, the WH-VM-PNC was able to perform more stably than a conventional cut tap.

Machining small diameter internal threads with Inconel 718

Tool	WH-VM-PNC 3,2 x 2,4 U32		Cutting Speed	N° of Passes	Number of Holes			
	Inconel 718 (40HRC)				20	40	60	80
Work Material	Inconel 718 (40HRC)		40m/min	4	50 Holes → Substantial tool chipping			
Cutting Speed	40m/min (3.980min ⁻¹)	60m/min (5.970min ⁻¹)			60 Holes → Substantial tool chipping			
Feed	120mm/min (0,03mm/t)	180mm/min (0,03mm/t)	60m/min	2	40 Holes → Substantial tool chipping			
Internal Thread Size	N°10~32 UNF							
Drill Hole Size	φ4,1x14mm (Blind)							
Tapping Length	9mm (1,9D) (Blind)							
Machining Method	Down Cut 2-4 passes							
Coolant	Water Soluble							
Machine	(HSK-A40) Vertical Machining Center							

Compared to taps, thread mills have fewer cutting condition limitations. There are no worries about chip management or coolant lubricity, and stable tapping is possible. In this example, we were able to improve the yield rate of small diameter internal threads in a high value workpiece. Further durability improvements and cost reductions can be expected by adjusting the feed rate and number of passes, and changing the cutting fluid.

Outstanding Performance in Stainless with Water-Soluble Coolant

Tool	WX-ST-PNC 7,5x9,1RC 28
Work Material	SUS304
Cutting Speed	130m/min (9.970min ⁻¹)
Feed	607mm/min (0,1mm/t)
Internal Thread Size	Rc 1/8-28
Drill Hole Size	φ8,2x9mm (Though)
Tapping Length	6,2 mm
Machining Method	Down Cut
Coolant	Water Soluble
Machine	Vertical Machining Center

Description	Number of Holes		
	500	1.000	1.500
WH-ST-PNC	1.315 Holes → Gauge-Out		
Competitor A	1.217 Holes → Gauge-Out		
Competitor B	1.000 Holes → Gauge-Out		

Tool life comparison against other competitors under identical cutting condition in SUS304. The tool life of the WX-ST-PNC was slightly higher than other competitors. Also, in terms of tool wear, it was the only tool that was in fair enough condition for regrinding.

Tool Wear Amount

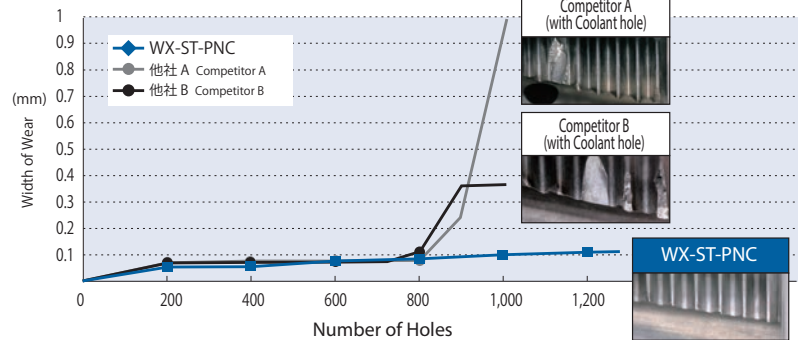

Stable performance in S45C

Tool	WX-ST-PNC 7,5x9,1RC 28
Work Material	S45C
Cutting Speed	100m/min (4.592min ⁻¹)
Feed	327mm/min (0,07mm/t)
Internal Thread Size	Rc 1/8-28
Drill Hole Size	φ8,2x9mm (Though)
Tapping Length	6,2 mm
Machining Method	Down Cut
Coolant	Water Soluble
Machine	Vertical Machining Center (BT30)

Pitch-dia. Reduced amount

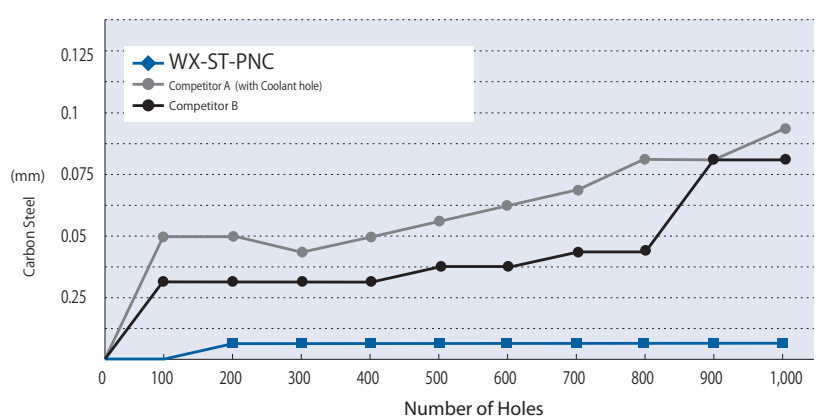

Cutting results in S45C. The WX-ST-PNC was able to stably process 1,000 holes with minimal changes in the effective diameter.

Long tool life when high-speed machining hardened steels

Tool	WXO-ST-PNC 9,5 x 26,3 P1,75
Work Material	SCM440 (40HRC)
Cutting Speed	100m/min (3.351min ⁻¹)
Feed	349mm/min (0.1mm/t)
Internal Thread Size	M12x1,75
Drill Hole Size	φ10,3
Tapping Length	20 mm
Machining Method	Down Cut 2 passes
Coolant	Water Soluble (10%) (Internal)
Machine	Vertical Machining Center

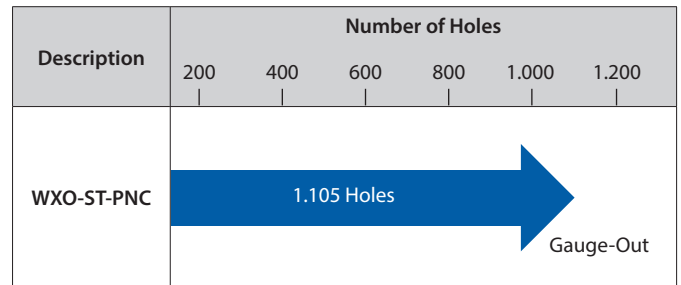

Machined continuously without making tool diameter corrections.

In this example, even when high-speed machining at 100m/min with internally supplied coolant, there was no chipping and long tool life was achieved. The internal threads' pitch diameter measurement was stable, demonstrating the effectiveness of this tool in mass production machining.

Pitch diameter of internal thread

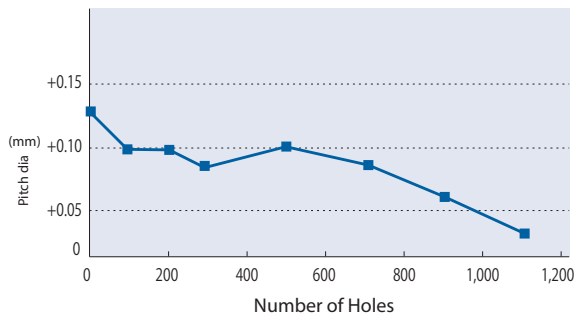

Changes in the extent of wear on the outer circumference

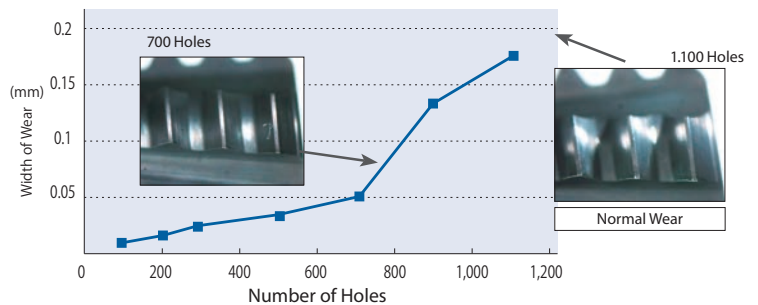

Stable machining in stainless steels, Wear is 40% less than the competitor

Tool	WXO-ST-PNC 9,5 x 26,6 P1,75
Work Material	SUS 304
Cutting Speed	80m/min (2.681min ⁻¹)
Feed	168mm/min (0,06 mm/t)
Internal Thread Size	M12x1,75
Tapping Length	23 mm
Coolant	Water Soluble
Machine	Vertical Machining Center (BT40)

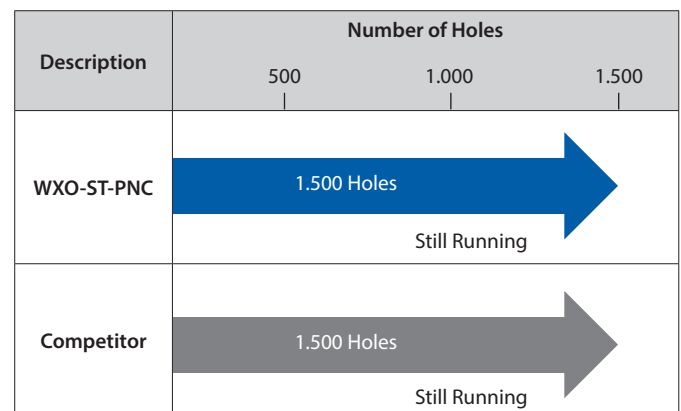

Even when machining stainless steel at 80m/min, it was possible to machine over 1,500 holes, and tool wear was 40% less than the competitor's product. Low wear, slow wear progression and long, stable machining of internal threads were achieved.

Changes in the extent of wear on the outer circumference

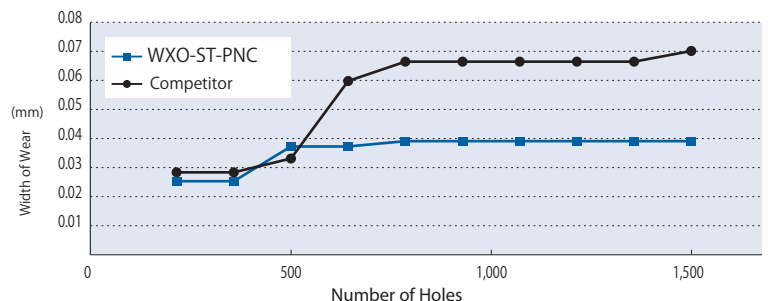

In non-ferrous materials, WX-PNC has excellent durability

Tool	WX-PNC 7,6 x 14,3 U16
Work Material	A7075
Cutting Speed	160m/min (6.701min ⁻¹)
Feed	650mm/min (0,16 mm/t)
Internal Thread Size	3/8-16
Tapping Length	12 mm
Coolant	Water Soluble
Machine	Vertical Machining Center (BT40)

Description	Number of Holes			
	2.000	4.000	6.000	8.000
WX-PNC	8.800 Holes			
	Still Running			
WX-PNC	8.800 Holes			
	Still Running			

Even after machining 8,800 holes in A7075 with a cutting speed of 160m/min, tool wear was negligible. It was still possible for the WX-PNC to continue much more, effectively achieving stable machining of internal threads on a machining center.



No.1 (after cutting 8,800 threads)



No.2 (after cutting 8,800 threads)

The WX-PNC is also for heat-resistant steels. It achieved twice the tool life of the competitor in Inconel 718

Tool	WX-PNC 4,55 x 10,8 U20
Work Material	Inconel 718 (43HRC)
Internal Thread Size	1/4-20 UNC
Tapping Length	9 mm
Feed per Tooth	0,03 mm/t
Coolant	Water Soluble (10%)
Machine	Horizontal Machining Center

Cutting Speed and Durability Count

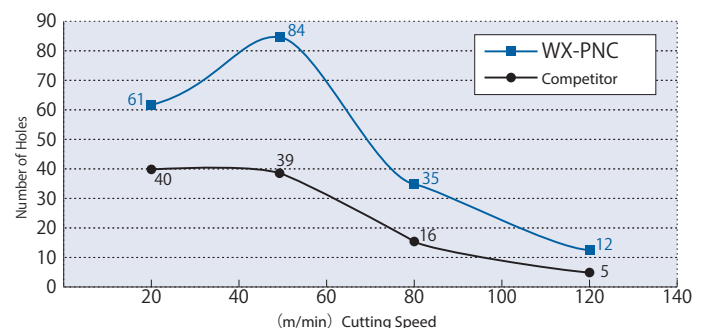

These are the test results in Inconel® 718 at various cutting speeds. At cutting speeds under 50m/min, durability is better and this seems to be an effective machining range. The WX-PNC achieves twice the tool life of the competitor, no matter the cutting speed.

FEEDBACK FROM THREADPRO USERS

"An increased variety of NC machines to select from has helped me a lot." (User)

"The RPRG is very convenient! Before RPRG, I set the depth of cut on a trial-and-error basis for the first session. Now I can confidently set the depth correctly the first time." (User)

"I have no trouble selecting a tool, although it has been difficult for me to find the right combination of a holder and an insert . (Distributor)

"It is very convenient and easy to select the type of the tool or cutting edge according to the cutting context." (User)

"The search results show relevant tool profiles and dimensions, for which I am glad." (User)

VOICE OF THREADPRO DEVELOPER

In recent years, various theories concerning cutting have been proposed for end milling, considering load control and cutting efficiency. This is due to higher flexibility in end milling than in tapping. Thread mill is a thread cutting tool. However, as cutting methods it is closer to end mills than taps. Accordingly, to achieve optimal thread milling, parameters should include the cutting path as well as other cutting conditions. Nevertheless, because the workings of a thread mill are inherently complex, it is very difficult for the user to achieve the proper arrangement. OSG has radically updated the NC program development software to enable users to realize their ideas with increased ease and make more effective use of their tools than before.



KEY FEATURES: AT-2

Helical drilling + threading can be done simultaneously !



AT-2: THREAD MILL WITH END-CUTTING EDGE FOR HIGH HARDNESS STEELS

No pilot hole is required!
Stable machining without chip trouble

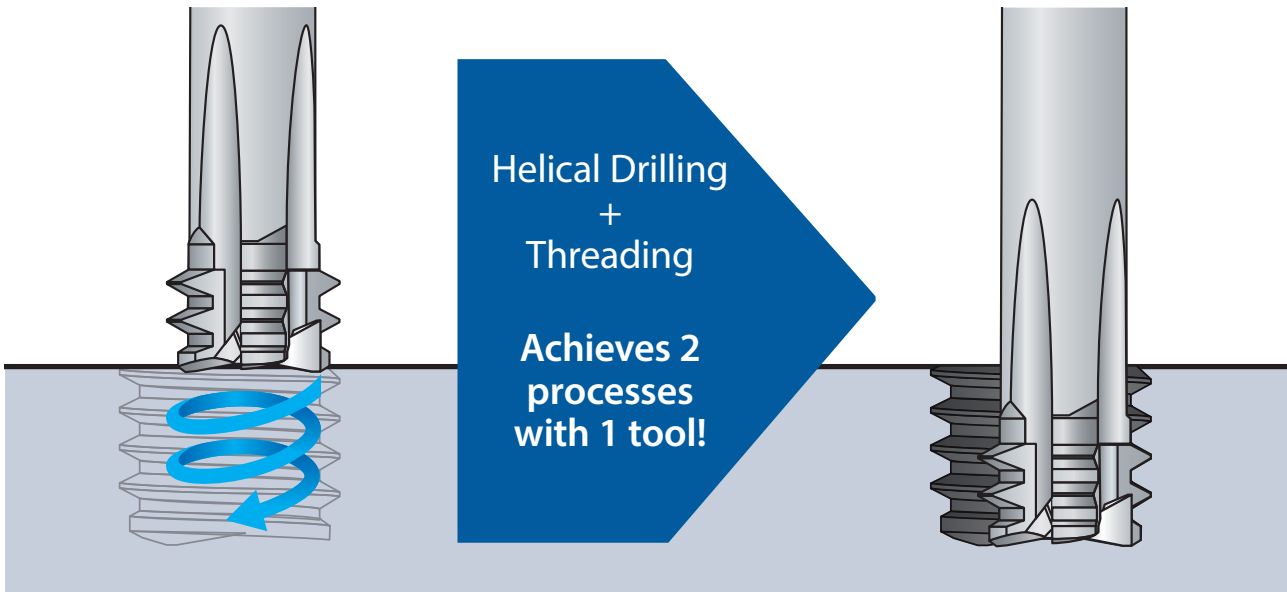

Threading | Thread milling

3 Supportive Tools for Your Thread Milling Needs

- 1 ThreadPro**
Creates programs easily
Thread Milling NC Code Generator Software

Web ThreadPro

AT-2 is supported by Web version only
Web version of ThreadPro is now available

- 2 RPRG**
Reduces correction works
Reference value of tool radius offset

- 3 DCT**
Stabilizes tool life
Diameter Correction Tool

AT-2 2D Type

Threading | Thread milling | Metric & Metric Fine

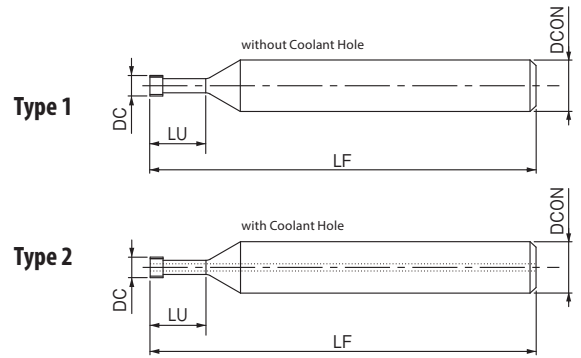

- First choice in quality and performance
- Thread mill with end-cutting edge for high hardness steels
- DUROREY coating

Threading | Thread milling

P ○ C < 0,2%	P ○ 0,25 < C < 0,4	P ○ C > 0,45%	P ○ SCM	M ○ INOX	K ○ GG	K ○ GGG	N ○ Al	N ○ AC,ADC	S ● Ti	S ● Ni	H ● 25-45 HRC	H ● 45-50 HRC	H ● 50-65 HRC	
35-55	80-160	80-160	60-120	35-100	35-100	35-100	35-100	35-100	35-55	35-55	35-75	35-65	35-55	m/min
0,01~0,07	0,01~0,07	0,01~0,07	0,01~0,07	0,01~0,07	0,01~0,07	0,01~0,07	0,01~0,07	0,01~0,07	0,01~0,07	0,01~0,07	0,01~0,07	0,01~0,07	0,01~0,07	mm/t



Metric & Metric fine

EDP	cutting bore ∅	Max. cutting bore ∅	DC	LF	Maximum threading length	LU	DCON	ZEFP	Type	Price
8331200	M3	4,2	2,4	50	6	7,25	6	4	1	
8331201	M4	5,3	3,1	50	8	9,75	6	4	1	
8331202	M5	7	4	50	10	12	6	4	1	
8331203	M6	8	4,6	50	12	14,5	6	4	1	
8331204	M8	10,9	6,2	70	16	19,2	10	4	1	
8331205	M10	13,2	7,5	70	20	23,75	10	4	2	
8331206	M12	15,9	9	80	24	28,37	10	4	2	
special item	M16	21,1	11,7	100	32	37	12	4	2	
special item	M18	25,1	14	135	36	42,25	16	4	2	
special item	M20	28,5	15,7	135	40	46,25	16	4	2	

AT-2 2,5D Type

Threading | Thread milling | Metric & Metric Fine



EDP	cutting bore ∅	Max. cutting bore ∅	DC	LF	Maximum threading length	LU	DCON	ZEFP	Type	Price
8331207	M3	4,2	2,4	50	7,5	8,75	6	4	1	
8331208	M4	5,3	3,1	50	10	11,75	6	4	1	
8331209	M5	7	4	50	12,5	14,5	6	4	1	
8331210	M6	8	4,6	50	15	17,5	6	4	1	
8331211	M8	10,9	6,2	70	20	23,12	10	4	1	
8331212	M10	13,2	7,5	70	25	28,75	10	4	2	
8331213	M12	15,9	9	80	30	34,37	10	4	2	
special item	M16	21,1	11,7	100	40	45	12	4	2	
special item	M18	25,1	14	135	45	51,25	16	4	2	
special item	M20	28,5	15,7	135	50	56,25	16	4	2	

AT-2 2D Type

Threading | Thread milling | U, UNJ, UNC, UNJC, UNF, UNJF

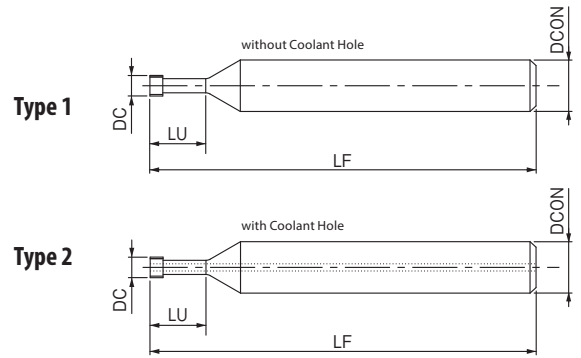

- First choice in quality and performance
- Thread mill with end-cutting edge for high hardness steels
- DUROREY coating

P ○ C < 0,2%	P ○ 0,25 < C < 0,4	P ○ C > 0,45%	P ○ SCM	M ○ INOX	K ○ GG	K ○ GGG	N ○ Al	N ○ AC,ADC	S ● Ti	S ● Ni	H ● 25-45 HRC	H ● 45-50 HRC	H ● 50-65 HRC	
35-55	80-160	80-160	60-120	35-100	35-100	35-100	35-100	35-100	35-55	35-55	35-75	35-65	35-55	m/min
0,01~0,07	0,01~0,07	0,01~0,07	0,01~0,07	0,01~0,07	0,01~0,07	0,01~0,07	0,01~0,07	0,01~0,07	0,01~0,07	0,01~0,07	0,01~0,07	0,01~0,07	0,01~0,07	mm/t



EDP	cutting bore ∅	Max. cutting bore ∅	DC	LF	Maximum threading length	LU	DCON	ZEFP	Type	Price
special item	N°8 - 32	4,7	3,1	50	8,33	10,31	6	4	1	
special item	N°10 - 24	6,1	3,7	70	9,65	12,29	6	4	1	
special item	1/4 - 20	7,6	4,55	70	12,7	15,87	6	4	1	
special item	1/4 - 28	8	4,55	70	12,7	14,96	6	4	1	
special item	5/16 - 18	9,7	5,7	80	15,88	19,4	10	4	1	
special item	3/8 - 16	11,6	6,7	80	19,05	23,01	10	4	1	
special item	7/16 - 14	13,3	7,7	80	22,22	26,75	10	4	2	
special item	1/2 - 13	16,2	9,2	80	25,4	30,28	10	4	2	

AT-2 2,5D Type

Threading | Thread milling | U, UNJ, UNC, UNJC, UNF, UNJF



EDP	cutting bore ∅	Max. cutting bore ∅	DC	LF	Maximum threading length	LU	DCON	ZEFP	Type	Price
special item	N°8 - 32	4,7	3,1	50	10,42	12,4	6	4	1	
special item	N°10 - 24	6,1	3,7	70	12,07	14,71	6	4	1	
special item	1/4 - 20	7,6	4,55	70	15,88	19,05	6	4	1	
special item	1/4 - 28	8	4,55	70	15,88	18,14	6	4	1	
special item	5/16 - 18	9,7	5,7	80	19,85	23,37	10	4	1	
special item	3/8 - 16	11,6	6,7	80	23,81	27,77	10	4	1	
special item	7/16 - 14	13,3	7,7	80	27,78	32,31	10	4	2	
special item	1/2 - 13	16,2	9,2	80	31,75	36,63	10	4	2	

AT-2: IDEAL FOR HIGHLY DIFFICULT HIGH HARDNESS STEEL APPLICATIONS!

Helical drilling + threading can be done simultaneously, which reduces the risk of potential machining problems in the processing of high hardness steels

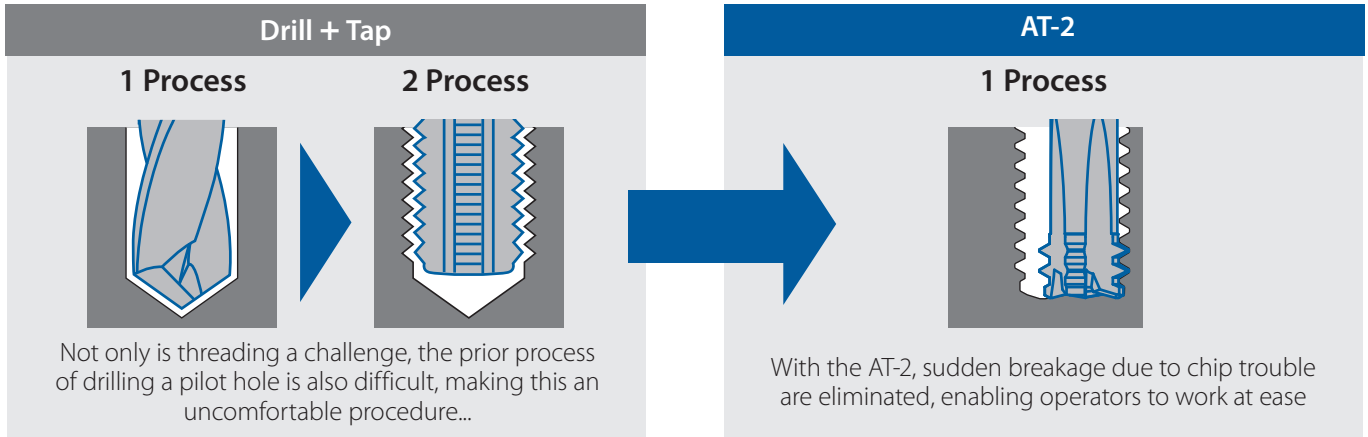

The risk of sudden tool breakage can be minimized by breaking chips into small and manageable pieces and evacuating them smoothly. Since no pilot hole is required, process integration and the risk of breakage can be avoided.

Long and stable tool life with higher thread quality compared to cutting taps

Tool	AT-2 Ø6,2 × 16 P1,25	Carbide hand tap for high hardness steels M8×1,25 3P
Work Material	SKD11 (60HRC)	
Cutting Speed	45m/min (2.310min ⁻¹)	2m/min (80min ⁻¹)
Feed	83mm/min(0,04m-m/t)	100mm/min
Drill Hole Size	None	Ø6,8 × 23,5mm (Blind)
Internal Thread size	M8×1,25	
Threading Length	16mm (2D)	
Coolant	Air Blow	Non-Water-Soluble
Machine	Horizontal Machining Center	Vertical Machining Center

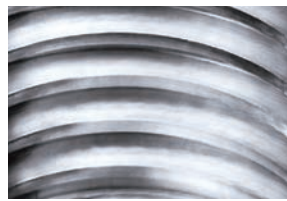
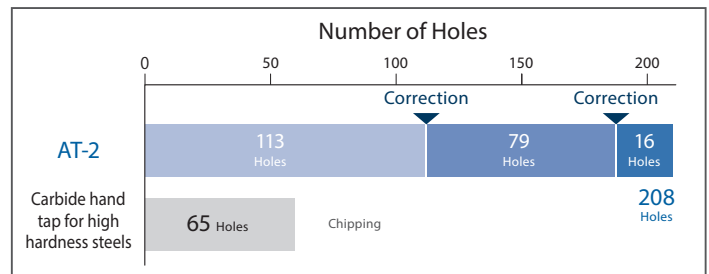

Coating Structure

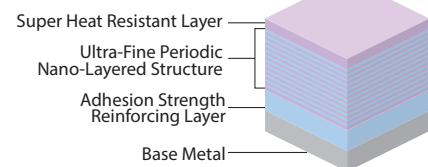

DUROREY

Newly developed DUROREY coating enables superior heat resistance and high toughness optimized for high-hardness steel milling!

Super heat resistant layer and ultra-fine periodic nano-layered structure provide superior toughness while maintaining high heat resistance and abrasion resistance. Also suppresses chipping even in high hardness milling and achieves long tool life.

Coating Color	Coating Structure	(GPa) Hardness	(C°) Oxidation Temperature	Heat Resistance	Adhesion Strength	Surface Roughness	Wear Resistance	Welding Resistance	Toughness
Black Gray	Ultra-Fine Periodic Nano-Layered	41	1.300	☆	◎	○	☆	◎	◎

○ → ◎ → ☆
Fair Best

Outstanding durability by cutting with air-blow

Size	Ø3,1 × 8 P0,7	Ø6,2 × 16 P1,25	Ø7,5 × 20 P1,5
Work Material	SKD11 (60 HRC)		
Cutting Speed	45 m/min (4.621min ⁻¹)	45 m/min (2.310min ⁻¹)	35 m/min (1.485min ⁻¹)
Feed	46 mm/min (0,011mm/t)	83 mm/min (0,04mm/t)	56 mm/min (0,038mm/t)
Internal Thread Size	M4 x 0,7	M8 x 1,25	M10 x 1,25
Threading Length	7 mm	14,8 mm	18,5 mm
Coolant	Air Blow		
Machine	(BT40) Horizontal Machining Center	(HSK63) Vertical Machining Center	

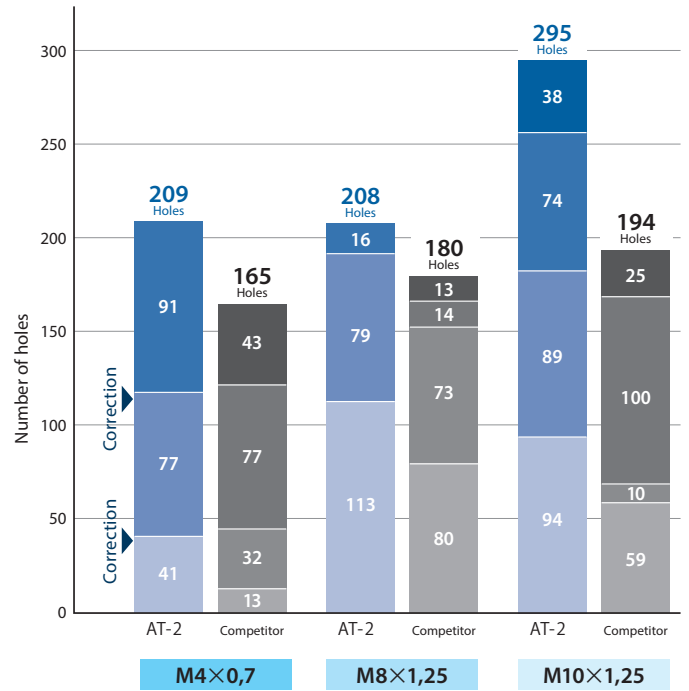

Stable durability with water-soluble coolant

Size	Ø4 × 10 P0,8	Ø7,5 × 20 P1,5
Work Material	SKD11 (60 HRC)	
Cutting Speed	45 m/min (3.581min ⁻¹)	45 m/min (1.910min ⁻¹)
Feed	66 mm/min (0,023mm/t)	73 mm/min (0,038mm/t)
Internal Thread Size	M5 x 0,8	M10 x 1,25
Threading Length	9,2 mm	18,5 mm
Coolant	Water-Soluble	
Machine	(BT40) Horizontal Machining Center	(HSK63) Vertical Machining Center

Unlike processing with cutting taps, which often involves the use of non-water-soluble coolant, water-soluble coolant can be used with the AT-2, reducing the need to replace machines.

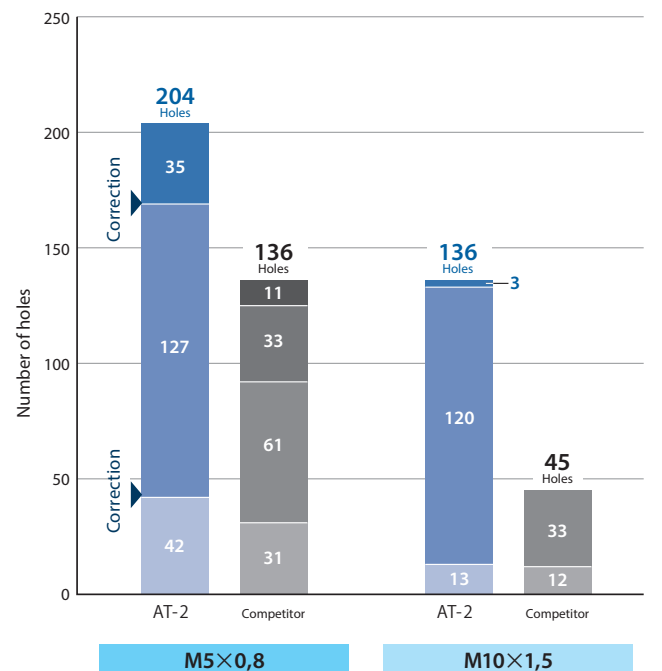

Stable threading of 2,5 x D made possible

Tool	AT-2 Ø7,5x25 P1,5
Work Material	SKD11 (60 HRC)
Cutting Speed	35 m/min (1.485min ⁻¹)
Feed	56 mm/min (0,038mm/t)
Internal Thread Size	M10 x 1,5
Threading Length	22,5 mm
Coolant	Air Blow
Machine	(HSK63) Vertical Machining Center

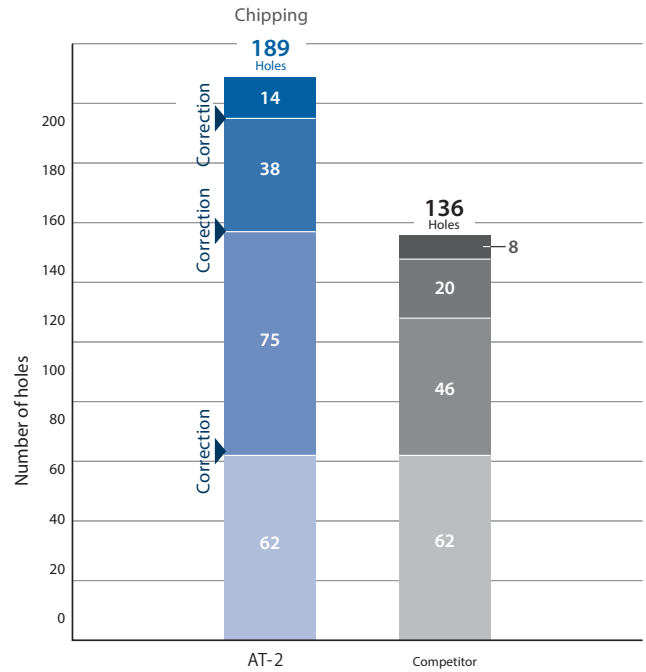

Remarkable durability in 65 HRC work material

Tool	AT-2 Ø4 x 10 P0,8
Work Material	(60 HRC) Equivalent to SKH
Cutting Speed	45 m/min (3.581 min ⁻¹)
Feed	29 mm/min (0,01 mm/t)
Internal Thread Size	M5 x 0,8
Threading Length	8 mm (2D)
Coolant	Air Blow
Machine	Horizontal Machining Center

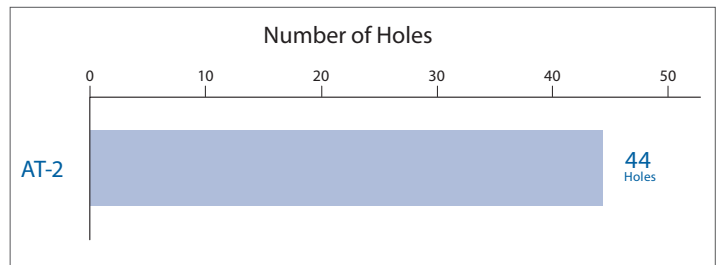

Please refer to the following table to select a suitable coolant for cutting.

Work Material	AT-2	
	Air Blow	Water-Soluble
High-hardness steel	⊙	△
General steel	×	⊙

⊙ : Best
 △ : Shortening of tool life
 × : Not recommended

Water-soluble cutting fluids can be used with satisfactory result, although in some cases the durability is inferior to air-blow.

Excellent durability even in STAVAX (around 50 HRC)

Tool	AT-2 Ø7,5x20 P1,5	
Work Material	STAVAX (53 HRC)	SKD (50 HRC)
Cutting Speed	55 m/min (2.331min ⁻¹)	
Feed	89 mm/min (0,038mm/t)	
Internal Thread Size	M10 X 1,5	
Threading Length	18 mm	
Coolant	Air Blow	
Machine	(BT40) Horizontal Machining Center	

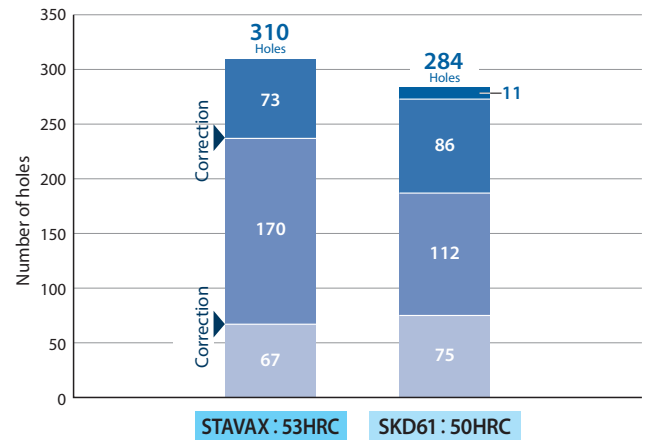

Stable performance even in general steels

Tool	AT-2 Ø3,1x8 P0,7	
Work Material	SS400	S50C
Cutting Speed	45 m/min (4.621min ⁻¹)	85 m/min (8.728min ⁻¹)
Feed	46 mm/min (0,011mm/t)	86 mm/min (0,011mm/t)
Internal Thread Size	M4 X 0,7	
Threading Length	7 mm (2D)	
Coolant	Water-Soluble	
Machine	Vertical Machining Center	

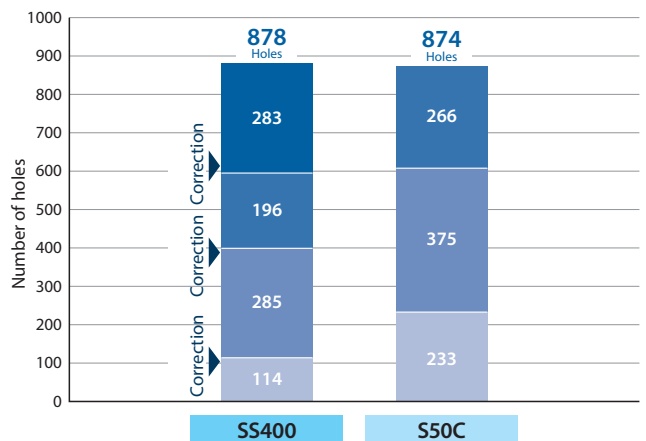

Since there is no cutting chip trouble, it is effective for avoiding the risk of tool breakage. Processing consolidation is also made possible.

Evaluation method of cutting test

- 1 Start the test by setting the 75% accuracy of internal thread to be the target of acceptable pitch diameter.
- 2 Perform correction when a gauge-out occurs and return to the target value.
- 3 Repeat steps 1 and 2 until processing after breakage or correction is less than 5 continuous holes.

Example : M8 x 1,25
Accuracy of Internal Thread : 6H (0~+0,16mm)
Target Value: 75%: +0,12mm

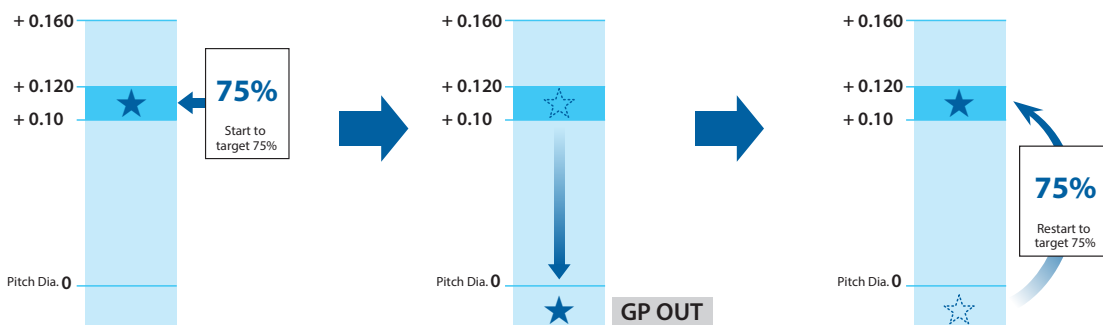

CUTTING CONDITIONS

Threading | Thread milling | Cutting conditions

AT-2

Work Material		Vc (m/min)	F (mm/tooth)
Mild Steel - Low Carbon Steel	C~0,25%	35~55	0,01~0,07
Medium Carbon Steel	C~0,25% ~ 0,45%	80~160	0,01~0,07
High Carbon Steel	C0,45%~	80~160	0,01~0,07
Alloy Steel	SCM	60~120	0,01~0,07
Hardened Steel	25~45 HRC	35~75	0,01~0,07
	45~50 HRC	35~65	0,01~0,07
	50~65 HRC	35~55	0,01~0,07
Stainless Steel	SUS - SUS420	35~100	0,01~0,07
Tool Steel	SKD	35~100	0,01~0,07
Cast Steel	SC	35~100	0,01~0,07
Cast Iron	FC	35~100	0,01~0,07
Ductile Cast Iron	FCD	35~100	0,01~0,07
Copper	Cu	35~100	0,01~0,07
Brass	Bs	35~100	0,01~0,07
Brass Casting	BsC	35~100	0,01~0,07
Bronze	PB	35~100	0,01~0,07
Aluminium Rolled Steel	AL	35~100	0,01~0,07
Aluminium Alloy Casting	AC, ADC	35~100	0,01~0,07
Magnesium Alloy Casting	MC	35~100	0,01~0,07
Zinc Alloy Casting	ZDC	35~100	0,01~0,07
Titanium Alloys	Ti-6AL-4V	35~55	0,01~0,07
Nickel Alloys	Inconel®	35~55	0,01~0,07
Thermosetting plastic	-	35~100	0,01~0,07
Thermoplastic	-	35~100	0,01~0,07

1. The indicated speeds and feeds are for Air Blow.
2. Please adjust the cutting conditions depending on the rigidity of machine, tool holders, and workpiece clamping.
3. Tool vibrations should be kept at a minimum level for maximum accuracy.
4. Please select a larger feed rate when the diameter of internal thread to be cut is large, and a smaller feed rate when it is small.
5. Please use water-soluble coolant when machining aluminum materials.
6. When machining magnesium alloy materials, please use the coolant oil recommended by the coolant oil manufacturer. Please also properly dispose the cutting chips to prevent fire hazards.

For titanium alloys and Ni-based alloys, the above condition table applies only when the oil hole compatible size is used with a water-soluble cutting fluid.

Formula for calculating the feed rate of thread mill

$$V_f = \frac{f \times z \times n \times (D_m \pm D_c)}{D_m} \text{ (mm/min)}$$

v_f	Feed (mm/min)	z	Number of Flutes
D_m	Actual Dia. (mm)	f	Feed (mm/t)
D_c	Tool Dia. (mm)	n	Speed (min ⁻¹)

Note Internal: - External: +

For the arc cutting process of machining external and internal threads, the feed rate at the tool center can be obtained by multiplying the linear cut feed rate with a coefficient. The formulas for calculating coefficients vary between external and internal thread cutting. The formula listed left are for calculating the tool feed rate during arc-cutting, including calculating the coefficients to be used for multiplication with the linear-cut feed rate.

PROPER USAGE OF COOLANT

When using external coolant, ensure that the cutting fluid is properly positioned so that it is supplied into the hole.

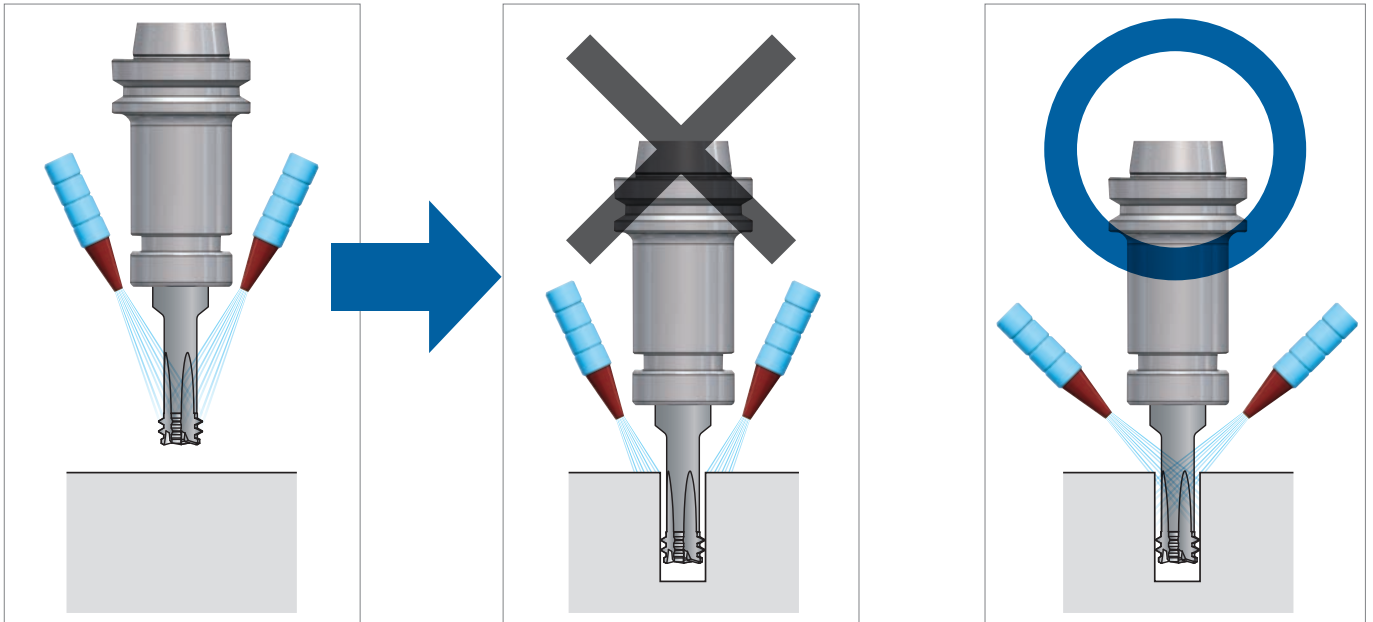

If you are using a machining center with a through-spindle coolant system, the use of coolant through collet is recommended.

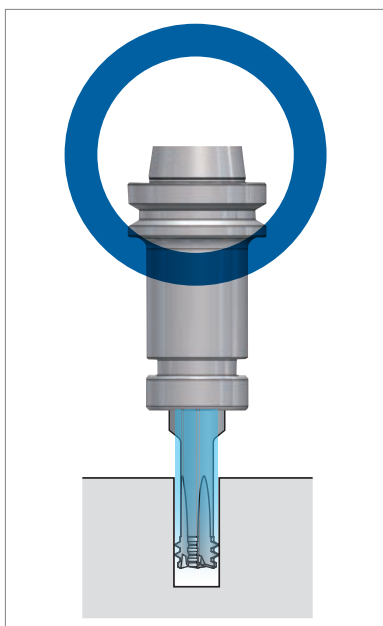

Please refer to the following table to select a suitable coolant for cutting.

Work Material	AT-2	
	Air Blow	Water-Soluble
High-hardness steel	◎	△
General steel	×	◎

◎ : Best
 △ : Shortening of tool life
 × : Not recommended

Water-soluble cutting fluids can be used with satisfactory result, although in some cases the durability is inferior to air-blow.



FEATURES: WH(O)-EM-PNC



WH-EM-PNC

Threading | Thread milling | Metric | Metric Fine

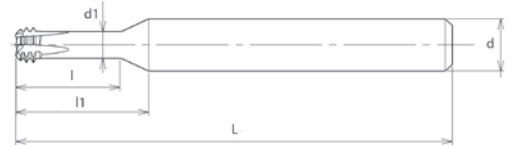

- Thread milling without pre-drilled hole
- WXS coating
- Left-hand (spindle rotation left)
- Direction of tool feed: right
- 4 flutes, strong & negative rake angle

P ○ C < 0,2%	P ○ 0,25 < C < 0,4	P ○ C > 0,45%	P ○ SCM	M ○ INOX	K ○ GG	K ○ GGG	N ○ Al	N ○ AC,ADC	S ● Ti	S ● Ni	H ● 25-45 HRC	H ● 45-55 HRC	H ● 55-65 HRC	
40-100	40-100	40-100	40-100	40-100	40-120	40-100	40-100	40-160	40-80	40-80	40-100	30-80	30-50	m/min
0,01~0,03	0,01~0,03	0,01~0,03	0,01~0,03	0,01~0,03	0,01~0,1	0,01~0,05	0,01~0,05	0,01~0,1	0,01~0,03	0,01~0,03	0,01~0,03	0,01~0,03	0,01~0,03	mm/t

M MF MJ CARBIDE WXS h6 LH

EDP	Old EDP	M	P	L	l	l1	d1	d	Z	Price
48347003	T1606081	3	0,5	50	7,5	12,3	1,70	6	4	
48347004	T1606082	4	0,7	50	9,9	14,2	2,18	6	4	
48347005	T1606083	5	0,8	50	12	15,5	2,97	6	4	
48347006	T1606084	6	1	50	14,5	17,5	3,36	6	4	
48347008	T1606085	8	1,25	70	19,2	24,1	4,66	10	4	
48347010	T1606086	10	1,5	70	23,7	27,7	5,78	10	4	
48347012	T1606087	12	1,75	80	28,4	31,4	6,92	10	4	

WHO-EM-PNC NEW

Threading | Thread milling | Metric | Metric Fine



- With internal coolant

P ○ C < 0,2%	P ○ 0,25 < C < 0,4	P ○ C > 0,45%	P ○ SCM	M ○ INOX	K ○ GG	K ○ GGG	N ○ Al	N ○ AC,ADC	S ● Ti	S ● Ni	H ● 25-45 HRC	H ● 45-55 HRC	H ● 55-65 HRC	
40-100	40-100	40-100	40-100	40-100	40-120	40-100	40-100	40-160	40-80	40-80	40-100	30-80	30-50	m/min
0,01~0,03	0,01~0,03	0,01~0,03	0,01~0,03	0,01~0,03	0,01~0,1	0,01~0,05	0,01~0,05	0,01~0,1	0,01~0,03	0,01~0,03	0,01~0,03	0,01~0,03	0,01~0,03	mm/t

M MF MJ CARBIDE WXS h6 LH

EDP	M	P	L	l	l1	d1	d	Z	Price
48348003	3	0,5	50	7,5	12,3	1,7	6	4	
48348004	4	0,7	50	9,9	14,2	2,18	6	4	
48348005	5	0,8	50	12	15,5	2,97	6	4	
48348006	6	1	50	14,5	17,5	3,36	6	4	
48348008	8	1,25	70	19,2	24,1	4,66	10	4	
48348010	10	1,5	70	23,7	27,7	5,78	10	4	
48348012	12	1,75	80	28,4	31,4	6,92	10	4	
48348014	14	2	90	33	37,9	6,62	12	4	
48348016	16	2	90	37	39,5	9,36	12	4	



WH(O)-EM-PNC: THREAD MILL WITH END-CUTTING EDGE FOR HIGH HARDNESS STEELS

No pilot hole is required!
Stable machining without chip trouble

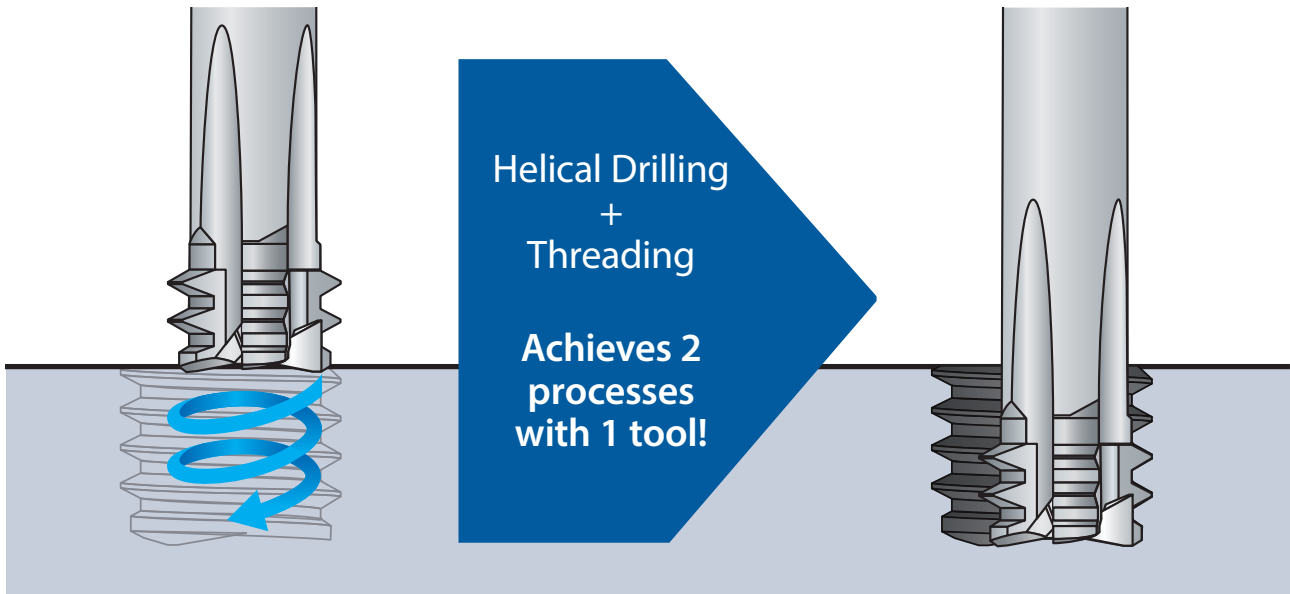

Threading | Thread milling

WH(O)-EM-PNC: IDEAL FOR HIGHLY DIFFICULT HIGH HARDNESS STEEL APPLICATIONS!

Helical drilling + threading can be done simultaneously, which reduces the risk of potential machining problems in the processing of high hardness steels

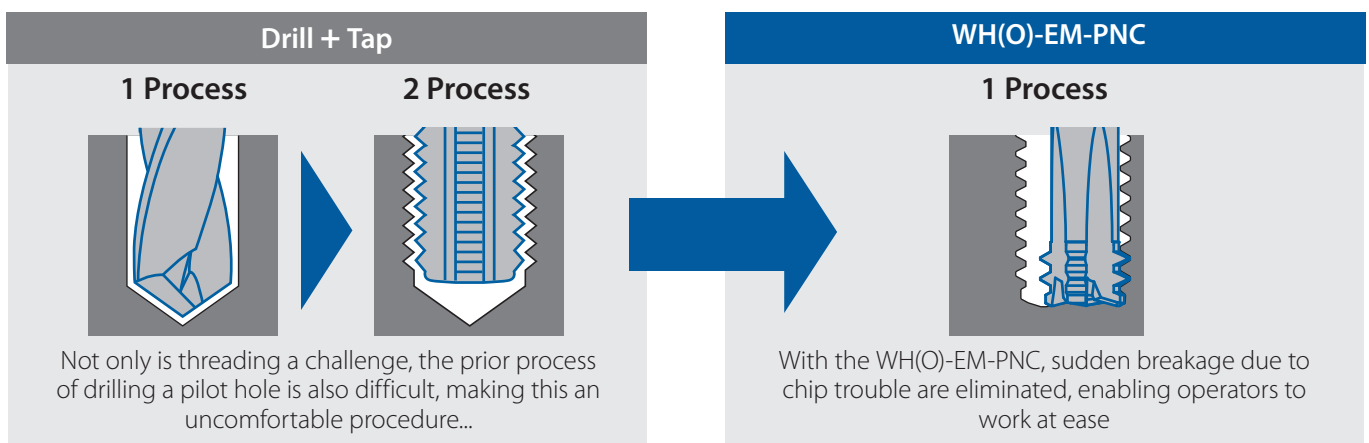

The risk of sudden tool breakage can be minimized by breaking chips into small and manageable pieces and evacuating them smoothly. Since no pilot hole is required, process integration and the risk of breakage can be avoided.

CUTTING DATA

Tool	WH-EM-PNC M4
Work Material	1.2379 (Cold work tool steel) 60HRC
Cutting speed	30 m/min (3.082 min ⁻¹)
Feed	123 mm/min (0.01 mm/t)
Depth of cut	8 mm
Coolant	Airblow
Machine	Exeron HSC600
Interface	HSK-40
Holder	Shrink holder
Hole type	Blind hole

Tool	WH-EM-PNC M4
Work Material	1.6582 (Alloy engineering steel) 1400-1550 N/mm ²
Cutting speed	50 m/min (5.137 min ⁻¹)
Feed	205 mm/min (0.01 mm/t)
Depth of cut	9 mm
Coolant	Airblow
Machine	Hermle C32U
Interface	HSK63-A
Holder	Hydraulic chuck
Hole type	Blind hole

Tool	WH-EM-PNC M4
Work Material	Vanadis (Cold work steel) 64HRC
Cutting speed	30 m/min (3.082 min ⁻¹)
Feed	123 mm/min (0.01 mm/t)
Depth of cut	8 mm
Coolant	Airblow
Machine	n.a.
Interface	n.a.
Holder	Shrink holder
Hole type	Blind hole



KEY FEATURES: DCT



1 Reduce setup & machining time

RPRG values are indicated on tool shank manufactured from November 2014. Now possible to reduce the checking and correction simply by entering the RPRG value.

2 Scale sleeve

Measurable range 100% ~ 50% tolerance of thread size (6H)

3 7 positions on the reading scale

With an attached reading scale, the effective diameter's position can be confirmed at a glance.

KEY FEATURES & BENEFITS

1 Reduce setup & machining time

The internal thread effective diameter, which used to be difficult to determine, can now be measured with readable values.

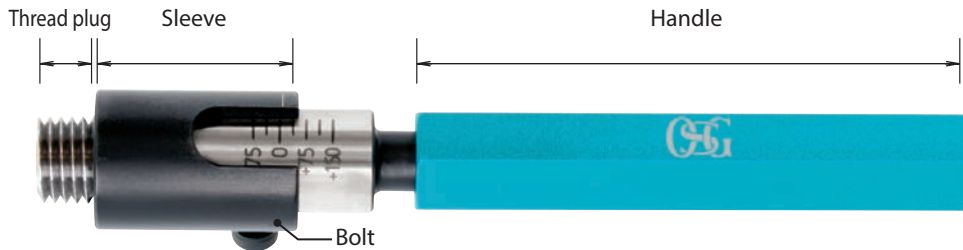

2 Scale sleeve

The DCT is made up of three components – the thread plug, scale sleeve and bolt for fixing the position. Measurable range from 100% ~ -50% tolerance of thread size (6H); with 7 positions on the reading scale.

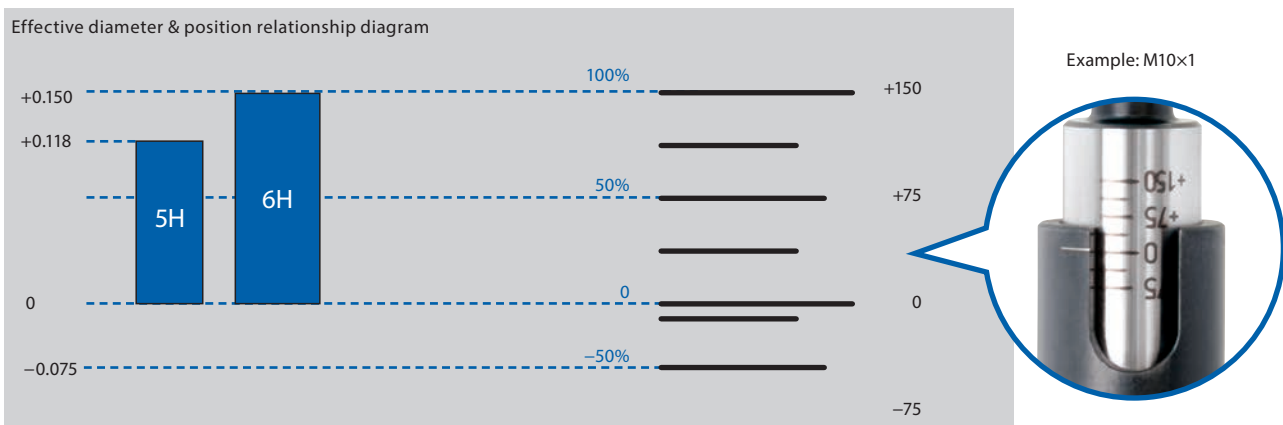

3 Measuring method

①

Insert the DCT into the thread. Turn the tool until it has reached the deepest position.

②

Release the reading sleeve so that it touches the top of the thread. Fix the bolt by screwing it tight.

③

Turn the tool in reverse to remove it from the thread.

④

Read the value on the scale.

* The reading value should be used as reference only. To inspect the screw thread please use the limit gauge (refer to p.6).
 * Depending on work environment this product may not be applicable.



- Diameter correction tool for thread mill
- Reduce the set up and machining time
- Measurable range 100% ~-50% tolerance of thread size 6H

Threading | Measuring

Metric

EDP	Thread size	Measurable depth (mm) in Blind Hole	Sleeve diameter	Price
9342000	M6 X 1 -1,5 D	9~	Ø13	
9342001	M8 X 1,25-1,5 D	12~	Ø13	
9342002	M8 X 1 -1,5 D	12~	Ø13	
9342003	M10 X 1,5 -1,2 D	12~	Ø15	
9342004	M10 X 1 -1,2 D	12~	Ø15	
9342005	M12 X 1,75 -1,2 D	14.4~	Ø17	
9342006	M12 X 1,5 -1,2 D	14.4~	Ø17	
9342007	M12 X 1,25 -1,2 D	14.4~	Ø17	
9342008	M14 X 2 -1,2 D	16.8~	Ø19	
9342009	M14 X 1,5 -1,2 D	16.8~	Ø19	
9342010	M14 X 1 -1,2 D	16.8~	Ø19	
9342011	M16 X 2 -1 D	16~	Ø21	
9342012	M16 X 1,5 -1 D	16~	Ø21	
9342013	M18 X 2,5 -1 D	18~	Ø23	
9342014	M18 X 1,5 -1 D	18~	Ø23	
9342015	M20 X 2,5 -1 D	20~	Ø25	
9342016	M20 X 1,5 -1 D	20~	Ø25	
9342017	M24 X 3 -1 D	24~	Ø29	

KEY FEATURES: E-DCT



1 Diameter correction tool for thread milled hole

2 Reduce the set up and machining time

3 Measuring level at the workpiece surface

4 Estimate the position within tolerance by notch

E-DCT: KEY FEATURES & BENEFITS

E-DCT Specification

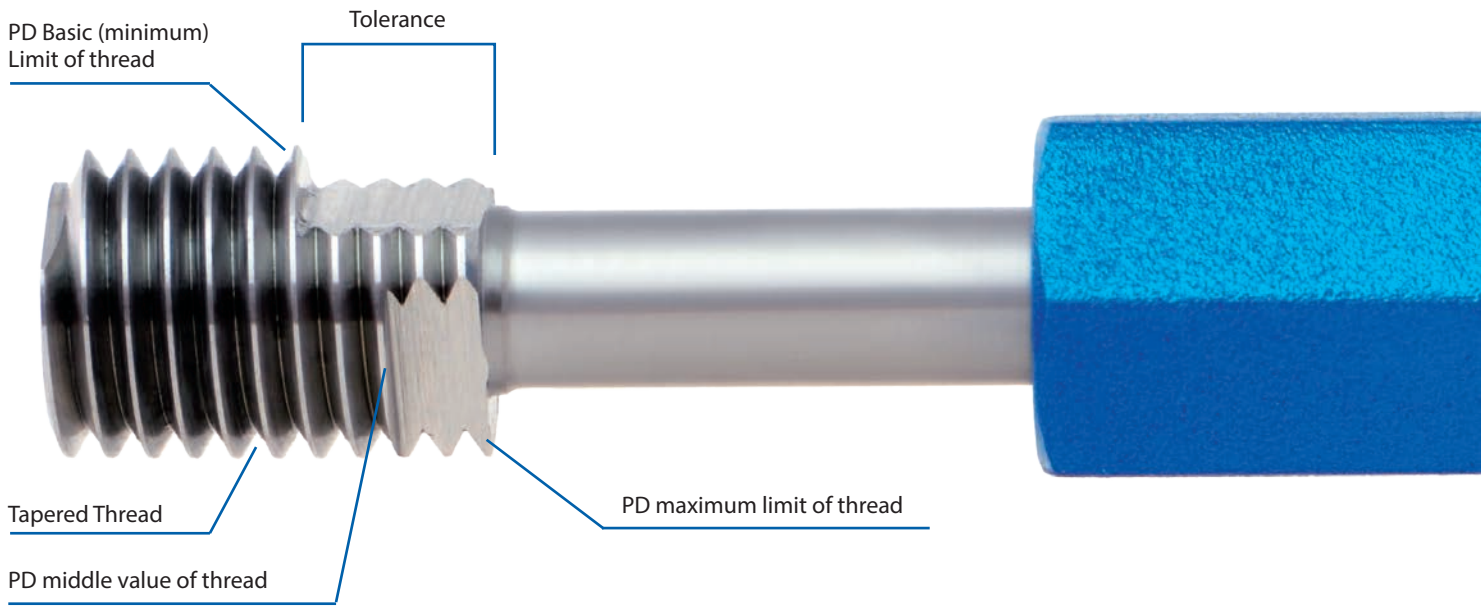

Judgement of internal thread with E-DCT



Hole No.	1	2	3	4	5
Position of gauge (depth) E-DCT					
GP gauge go through	NG	NG	NG (not go through)	OK	OK
NP gauge stop	OK	OK	OK	OK	NG
Judgement	NG (-)	NG (0)	NG	OK	NG (+)
Reason of Judgement	Smaller than Basic Pitch Diameter	Pitch Diameter is around Basic Pitch Diameter	Internal thread Tapered		Larger than maximum tolerance of Pitch Diameter

1. Estimate the PD by position of the notches

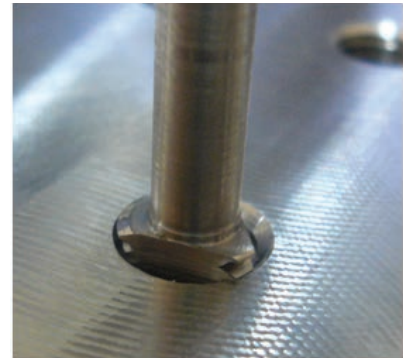
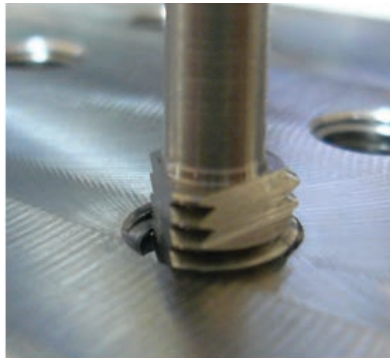
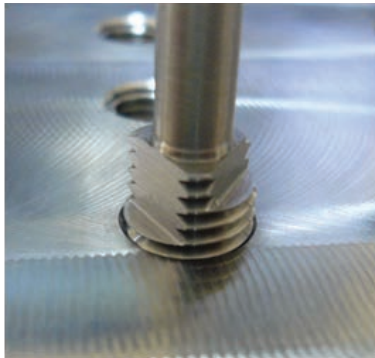

1.1 Work surface is between 1st notch and 2nd notch

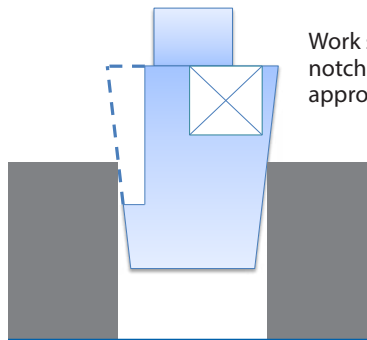
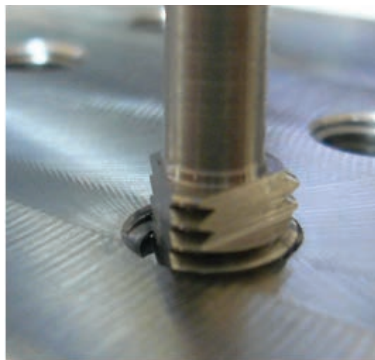

Work surface is between 1st notch and 2nd notch, which is approx. 1/4 of PD tolerance.

Example: M10X1.5 6H
Tolerance
9.026 +0.180 / 0
 $+0.180 \times 1/4 = +0.045$

PD of the thread is about +0.045

1.2 Work surface is between 2nd notch and 3rd notch

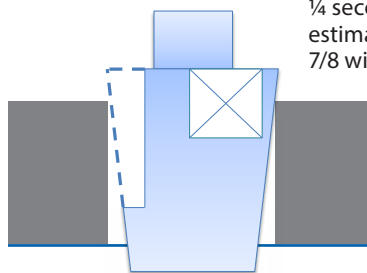

Work surface is at upper position about 1/4 second and third notch. Soof you can estimate PD is about 7/8 within tolerance.

Example: M10X1.5 6H
Tolerance
9.026 +0.180 / 0
 $+0.180 \times 7/8 = +0.158$

PD of the thread is about +0.160

1.3 Work surface is below the first notch (minimum limit)

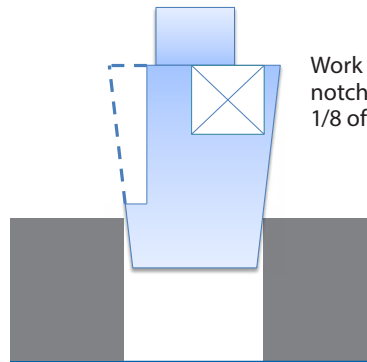
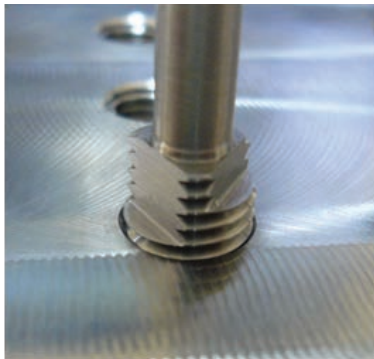

Work surface is below the first notch (Bottom Limit), about 1/8 of PD tolerance.

Example: M10X1.5 6H
Tolerance
9.026 +0.180 / 0
+0.180X -1/8 = -0.023

PD of the thread is about -0.020. (Not pass for small PD)

1.4 Work surface is over the 3rd notch (maximum limit)

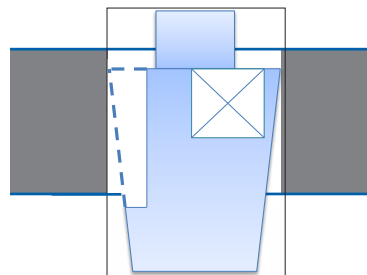
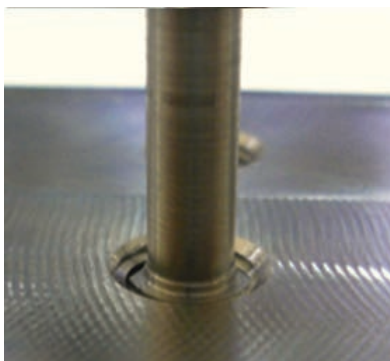

Work surface is over the 3rd notch (maximum Limit), about 1/8 of PD tolerance.

Example: M10X1.5 6H
Tolerance
9.026 +0.180 / 0
+0.180X +9/8 = +0.203

PD of the thread is about +0.203. (Not pass for large PD)

How to calculate the correction value?

- 1) After threadmilling inspect the female thread with a plug gauge GP-NP.
- 2) After process 1), inspect position of pitch diameter with "E-DCT"
- 3) Notch ① indicates the tolerance of the pitch diameter.
Notch ② indicates medium value of tolerance and over.

E-DCT shows pitch diameter value is around 0 in the below photo.



Ex) M10X1.5-6H Tolerance of pitch diameter is 0.180
pitch diameter value is around 0 as show on left photo.
If target value is 75% of tolerance , threadmill should rotate larger.

Correction value should be

- Based on diameter = $0.180 \times 75\% = 0.135$
- Based on semi-diameter = $0.135 / 2 = 0.068$

Tolerance of pitch diameter is marked on shank of E-DCT.
Tolerance of pitch diameter x ratio of notch(%) = correction value.



E-DCT

Threading | Measuring | UNJC | UNJF



- Diameter correction tool for thread mill
- Reduce the set up and machining time

UNJC

UNJF

For 3B

EDP	Thread size		Price
G1609623	1/4 - 20	UN(J)C	
G1609624	1/4 - 28	UN(J)F	
G1609625	5/16 - 18	UN(J)C	
G1609626	5/16 - 24	UN(J)F	
G1609627	3/8 - 16	UN(J)C	
G1609628	3/8 - 24	UN(J)F	
G1609631	1/2 - 13	UN(J)C	
G1609632	1/2 - 20	UN(J)F	
G1609635	5/8 - 11	UN(J)C	
G1609636	5/8 - 18	UN(J)F	
G1609638	3/4 - 16	UN(J)F	

For EG-3B Helicoil

EDP	Thread size		Price
G1609723	1/4 - 20	UN(J)C	
G1609724	1/4 - 28	UN(J)F	
G1609726	5/16 - 24	UN(J)F	
G1609728	3/8 - 24	UN(J)F	
G1609731	1/2 - 13	UN(J)C	
G1609732	1/2 - 20	UN(J)F	
G1609736	5/8 - 18	UN(J)F	
G1609738	3/4 - 16	UN(J)F	

Threading | Measuring



UNJF

DCT75 NEW

Threading | Measuring | U, UNJ



- Diameter correction tool for thread mill
- Reduce the set up and machining time
- Possible to aim at 75% from the min. pitch diameter tolerance

UNC

UNF

UNEF

EDP	Thread size	Thread length	d	Taper	Applicable Recommended Height Master
9342028*	1/4 - 20 UNC	7	⌀ 10	1/25	⑧
9342029*	1/4 - 28 UNF	5	⌀ 10	1/25	⑧
9342030*	5/16 - 18 UNC	7	⌀ 10	1/25	⑧
9342031*	5/16 - 24 UNF	7	⌀ 10	1/25	⑧
9342032*	5/16 32 UNEF	5	⌀ 10	1/25	⑧
9342033*	3/8 - 16 UNC	8,8	⌀ 10	1/25	⑦
9342034*	3/8 - 24 UNF	7	⌀ 10	1/25	⑦
9342035*	7/16 14 UNC	10	⌀ 12	1/25	⑦
9342036*	7/16 - 20 UNF	7	⌀ 12	1/25	⑦
9342037*	1/2 13 - UNC	10,8	⌀ 13	1/25	⑦
9342038*	1/2 - 20 UNF	7	⌀ 13	1/25	⑦

* Please be sure to purchase the DCT75 and the height master as a set.



U, UNJ

DCT75 DIGITAL INDICATOR

Threading | Measuring



- High performance type
- Digital display system
- Eliminate measurement and calculation with a digital display

EDP	Application size	Sleeve dia	Sleeve hole dia	Application Tapper
9342052*	M6 ~ M16 U1/4~1/2	∅ 23,5	∅ 17,5	1/25
9342053*	R (PT) 1/16 ~ 3/8	∅ 23,5	∅ 17,5	1/16

* Please be sure to purchase the DCT75 and the height master as a set.



DCT75 HEIGHT MASTER

Threading | Measuring

	EDP	Size
①	9342043*	28
②	9342044*	28,25
③	9342045*	28,5
④	9342046*	28,75
⑤	9342047*	29
⑥	9342048*	29,25
⑦	9342049*	29,5
⑧	9342050*	29,75
⑨	9342051*	30

* Please be sure to purchase the DCT75 and the height master as a set.



shaping your dreams

OSG EUROPE LOGISTICS

Avenue Lavoisier 1
B-1300 Z.I. Wavre - Nord - Belgium
Tel: +32 10 23 05 07
Fax: +32 10 23 05 51
info@osgeurope.com

OSG BELUX

Avenue Lavoisier 1
B-1300 Z.I. Wavre - Nord - Belgium
Tel: +32 10 23 05 11
Fax: +32 10 23 05 31
info@osg-belgium.com

OSG FRANCE

Parc Icade, Paris Nord 2
Immeuble "Le Rimbaud"
22 Avenue des Nations
CS66191 - 93420 Villepinte - France
Tel: +33 1 49 90 10 10
Fax: +33 1 49 90 10 15
sales@osg-france.com

OSG NETHERLANDS

Bedrijfsweg 5 - 3481 MG Harmelen
Tel: +31 348 44 2764
Fax: +31 348 44 2144
info@osg-nl.com

OSG UK

Shelton house, 5 Bentalls
Pipps Hill Ind Est, Basildon Essex SS14 3BY
Tel: +44 1268 567 660
Fax: +44 1268 567 661
uk_sales@osg-uk.com

CZECH, SLOVAKIA, HUNGARY

OSG Europe Logistics S.A.
Slovakia organizacna zlozka
Racianská 22/A, SK-83102 Bratislava
Slovakia
Tel. +421 24 32 91 295
Orders-osgsvk@osgeurope.com

OSG POLAND Sp. z.o.o.

Spółdzielcza 57
05-074 Halinów - Poland
Tel: +22 760 82 71
Fax: +22 760 82 71
osg@osg-poland.com

OSG GERMANY

Karl-Ehmann-Str. 25
D - 73037 Göppingen - Germany
Tel: +49 7161 6064 - 0
Fax: +49 7161 6064 - 444
info@osg-germany.de

OSG SCANDINAVIA

(For Scandinavian countries)
Langebjergvaenget 16
4000 Roskilde - Denmark
Tel: +45 46 75 65 55
Fax: +45 46 75 67 00
osg@osg-scandinavia.com

SWEDEN

Branch office of OSG SCANDINAVIA
Abrahams Gränd 8
295 35 Bromölla - Sweden
Tel: +46 40 41 22 55
Fax: +46 40 41 32 55
osg@osg-scandinavia.com

OSG IBERICA

Bekolarra 4
E - 01010 Vitoria-Gasteiz - Spain
Tel: +34 945 242 400
Fax: +34 945 228 883
osg.iberica@osg-ib.com

RUSSIA

Butlerova street, 17B, office 5069
117342 Moscow - Russia
Tel: +7 (495) 150 41 54
info@osg-russia.com

OSG TURKEY

Rami Kişla Cad.No:56 Eyüp
Istanbul 34056 - Turkey
Tel:+90 212 565 24 00
Fax: +90 212 565 44 00
info@osg-turkey.com

ROMSAN INTERNATIONAL CO. SRL

Reprezentant Exclusiv OSG
25C, Bucuresti-Magurele Street
051431 Bucuresti - România
Tel: +40 21 322 07 47
Fax: +40 21 321 56 00
romsan.int@romsan.ro

AUSTRIA

Branch office of OSG GERMANY
Messestraße 11
A-6850 Dornbirn
Tel: +49 7161 6064-0
Fax: +49 7161 6064-444
info@osg-germany.de

OSG ITALIA

Via Ferrero, 65 A/B
I - 10098 Rivoli - Italy
Tel: +39 0117705211
Fax: +39 0117705215
info@osg-italia.it

Vischer & Bolli AG

Machining and Workholding
Im Schossacher 17
CH-8600 Dübendorf
T +41 44 802 15 15
F +41 44 802 15 95
info@vb-tools.com

OSG EUROPE LOGISTICS S.A.

10/2020 - All rights reserved. © OSG Europe 2020.

The contents of this catalogue are provided to you for viewing only. They are not intended for reproduction either in part or in whole in this or other medium. They cannot be copied, used to create derivation work or used for any reason, by means without the express, written permission of the copyright owner. If prices are stated, they are netto unit-prices and any eventual tax(es) have to be added. The company is not responsible for any printing error in technical, price and/or any other data.

Tool specifications subject to change without notice.

www.osgeurope.com