

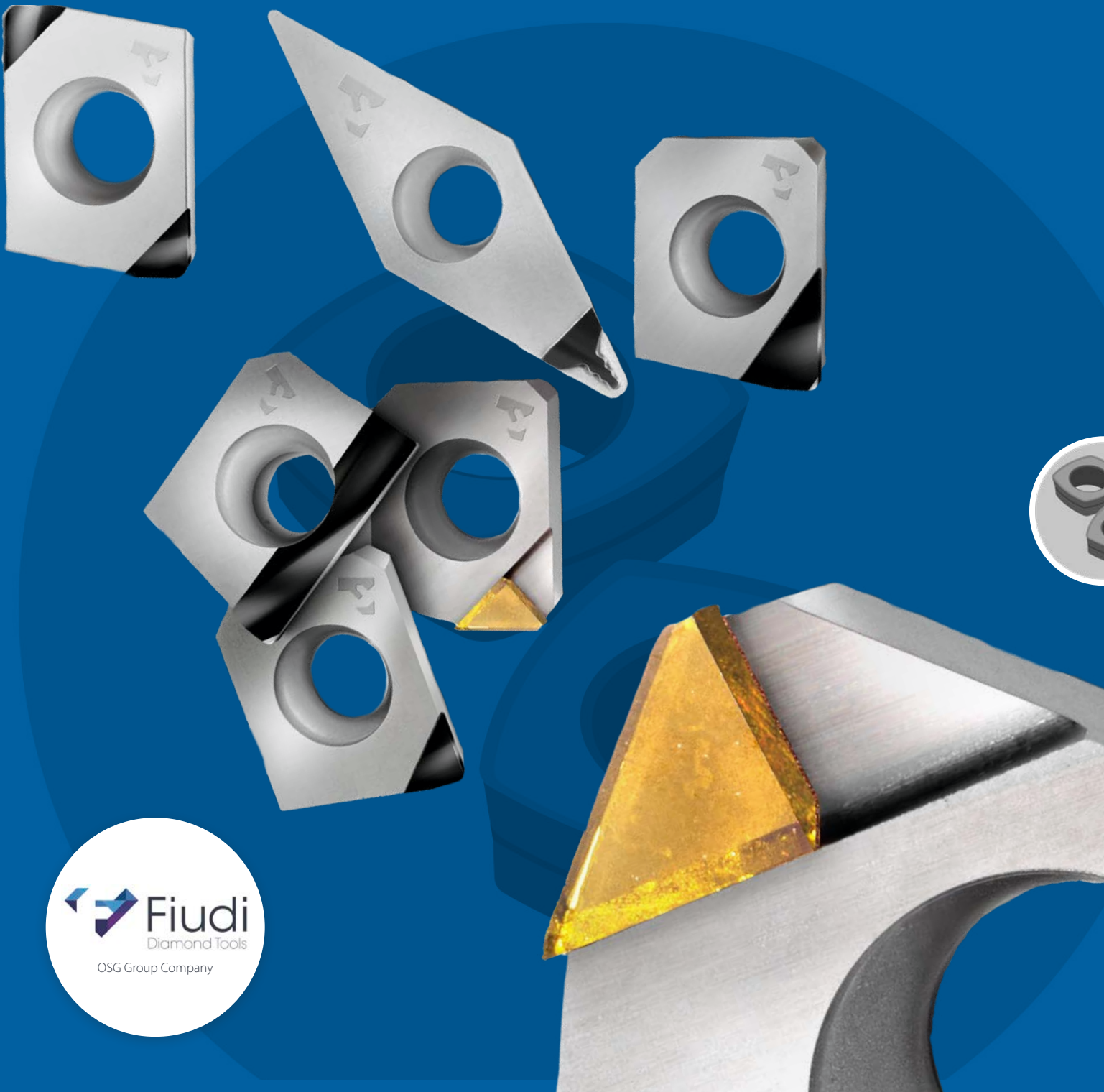

CBN & PCD Turning Inserts

INSERTS

Volume 1



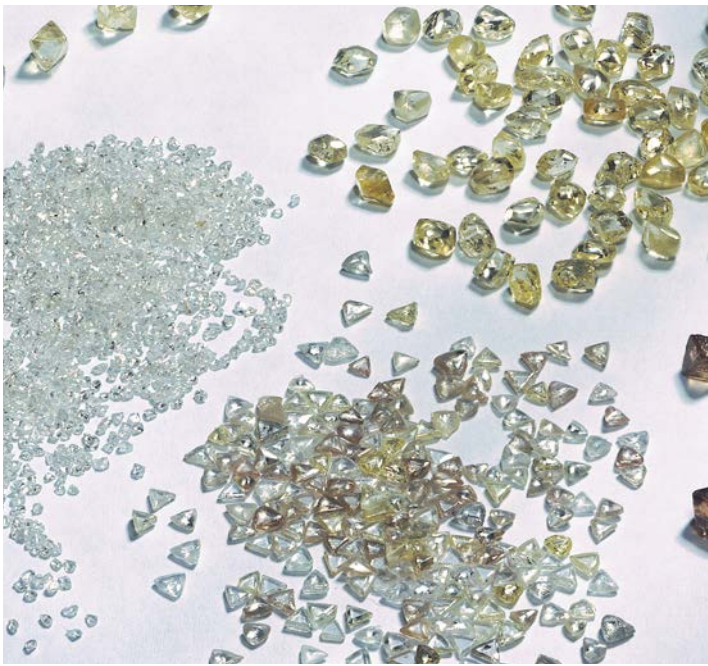
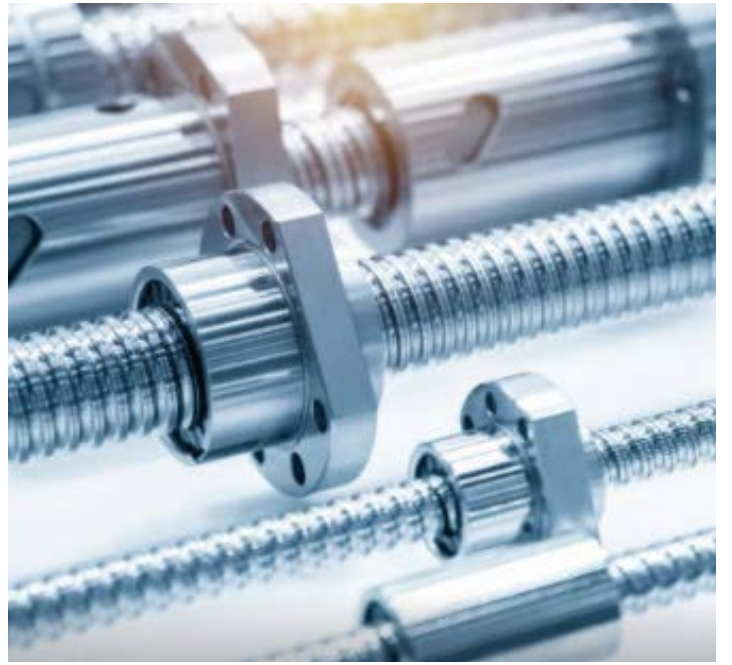
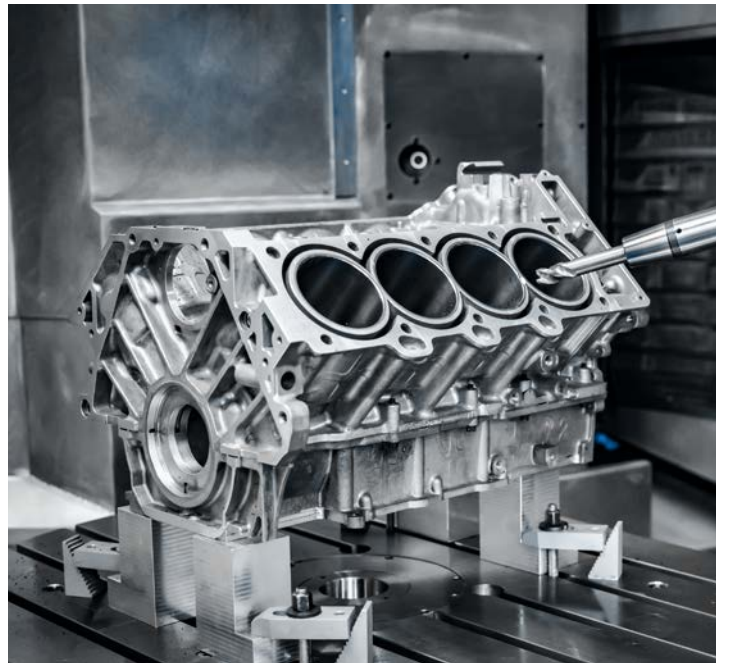

INTRODUCTION

FIUDI JOINS OSG GROUP

FIUDI of Turin (Italy) has joined the Japanese OSG Group.

With the acquisition of FIUDI, a medium size company specialized in developing and manufacturing of PCD, PcBN, Monocrystal Tools, OSG will strengthen its market position in Europe. With over 60 years of experience FIUDI is present with its technological solutions in AUTOMOTIVE, AEROSPACE, OIL & GAS segments.

Thanks to investments and synergies with OSG, FIUDI sets itself the goal to grow in the development of products and processes.





CUTTING EDGE GEOMETRY CBN

Turning | Indexables | Application

CUTTING EDGE GEOMETRY

Application

CUTTING EDGE GEOMETRY

Features of chamfer width and angle

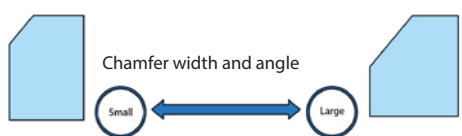

Cutting force	low ↔ high
Wear resistance	Good ↔ Poor
Chipping resistance	Good ↔ Poor
Application	Continuous ↔ Interrupted

As the reinforcement plane and rake angle increase, the strength of the cutting edge increases, allowing for higher feed rates.

If the goal is the stability of the machining and the consequent tool life of the cutting edge, the best choice must be the largest rake.

If the part to be machined requires a good surface finish and compliance with dimensional tolerances, a cutting edge with a smaller chamfer is recommended in order to reduce cutting forces, temperatures and any vibrations.

COATING

Technical specifications

● EU Stock - ● Fiudi stock - ○ On demand

GENERAL CHARACTERISTICS							
Letter	Composition	Hardness (HV) ISO 14577-4	T° deposition (C°)	T° max. use (C°)	Thickness Micron	Colour	Stock
A	AlTiN	2800 - 3200	400°	1100°	2 - 12	Grey - Purple	○
B	AlCrN	2800 - 3200	450°	1100°	3 - 6	Grey	●/●
C	AlTiSiN	2900 - 3300	450°	1100°	2 - 4	Bronze	○
T	TiN	2500 - 2700	450°	520°	2 - 5	Yellow	○

INSERTS DESCRIPTION

Turning | Indexables

Turning Inserts CBN | Indexables

Inserts

Insert shape	
A	Parall.85°
B	Parall.82°
C	Romb.80°
D	Romb.55°
E	Romb.75°
H	Hexagon
K	Parall.55°
L	Rectangle
M	Romb.86°
O	Octagon
R	Round
S	Square
T	Triangle
V	Romb. 35°
W	Trigon
X	Non ISO

Tolerance										
class of Tolerance	Tolerance ± mm			Inside circle						
	emq quote	Thickness	C.I.	3.96	4.76	5.55	6.35	7.93	9.52	12.7
A	±0.005	±0.025	±0.025	•	•	•	•	•	•	•
C	±0.013	±0.025	±0.025	•	•	•	•	•	•	•
E	±0.025	±0.025	±0.025	•	•	•	•	•	•	•
F	±0.005	±0.025	±0.013	•	•	•	•	•	•	•
G	±0.025	±0.13	±0.025	•	•	•	•	•	•	•
H	±0.013	±0.025	±0.013	•	•	•	•	•	•	•
J	±0.005	±0.025	±0.05	•	•	•	•	•	•	•
			±0.1							
K	±0.013	±0.025	±0.05	•	•	•	•	•	•	•
			±0.1							
M	±0.08	±0.13	±0.05	•	•	•	•	•	•	•
			±0.13	•	•	•	•	•	•	•
			±0.15	•	•	•	•	•	•	•
N	±0.08	±0.025	±0.05	•	•	•	•	•	•	•
			±0.13	•	•	•	•	•	•	•
			±0.15	•	•	•	•	•	•	•
U	±0.13	±0.13	±0.08	•	•	•	•	•	•	•
			±0.20	•	•	•	•	•	•	•
			±0.27	•	•	•	•	•	•	•

Insert size	

Radius	
00	r = 0 / Round
01	r = 0.1
02	r = 0.2
04	r = 0.4
08	r = 0.8
12	r = 1.2
16	r = 1.6

R

N

G

N

16

04

00

Insert clearance angle	
N	0°
A	3°
B	5°
C	7°
P	11°
D	15°
E	20°
F	25°
G	30°
0	different spec.

Insert type	
N	
R	
F	
A	
M	
G	
W	
T	
H	
X	Special

Insert thickness	
01	s=1.58
T1	s=1.98
02	s=2.38
03	s=3.18
T3	s=3.97
04	s=4.76
05	s=5.55
06	s=6.35

INSERTS DESCRIPTION

Turning | Indexables

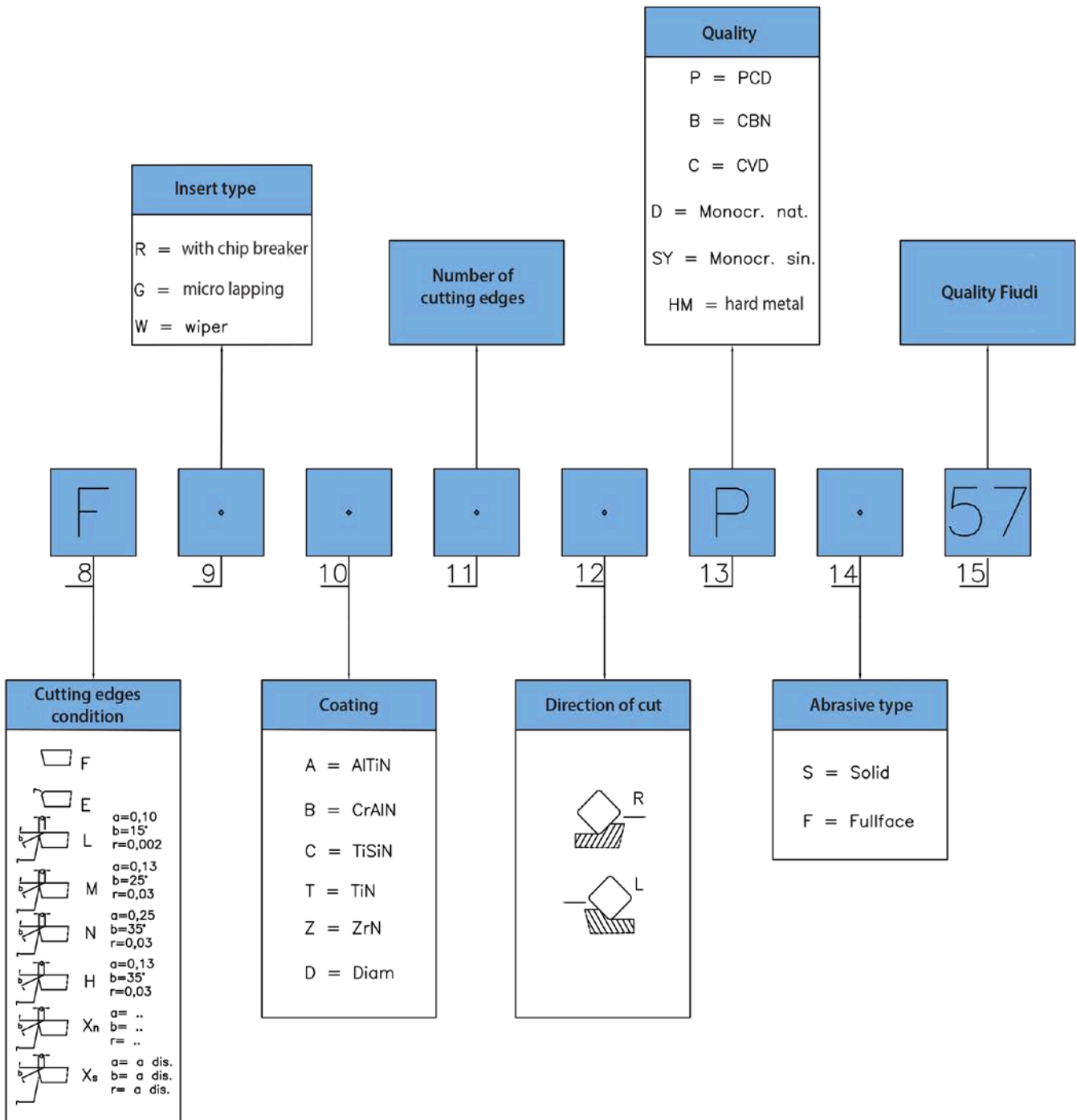

INSERTS

Turning | CBN

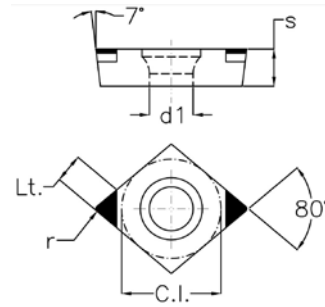
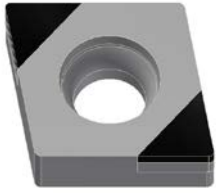

■ Insert two cutting edges type CCGW...

● EU Stock - ● Fiudi stock - ○ On demand

EDP	DESCRIPTION	c.i.	s	r	Lt	d1	K		H		Sintered steel		Price
							09	11	901	882	883	879	
							Stock	Stock	Stock	Stock	Stock	Stock	
223-027698-11LB	CCGW060202LB2B	6,35	2,38	0,2	2,8	2,8	○						
223-027698-882LB	CCGW060202LB2B	6,35	2,38	0,2	2,8	2,8			●				
223-027698-11MB	CCGW060202MB2B	6,35	2,38	0,2	2,8	2,8	○						
223-027698-882MB	CCGW060202MB2B	6,35	2,38	0,2	2,8	2,8			○				
223-027035-11EB	CCGW060204EB2B	6,35	2,38	0,4	2,7	2,8	○						
223-027035-882EB	CCGW060204EB2B	6,35	2,38	0,4	2,7	2,8			○				
223-027035-11LB	CCGW060204LB2B	6,35	2,38	0,4	2,7	2,8	○						
223-027035-882LB	CCGW060204LB2B	6,35	2,38	0,4	2,7	2,8			●				
223-027035-11MB	CCGW060204MB2B	6,35	2,38	0,4	2,7	2,8	●						
223-027035-882MB	CCGW060204MB2B	6,35	2,38	0,4	2,7	2,8			●				
223-032195-11LB	CCGW09T302LB2B	9,52	3,97	0,2	2,8	4,4	○						
223-032195-882LB	CCGW09T302LB2B	9,52	3,97	0,2	2,8	4,4			○				
223-032195-11MB	CCGW09T302MB2B	9,52	3,97	0,2	2,8	4,4	○						
223-032195-882MB	CCGW09T302MB2B	9,52	3,97	0,2	2,8	4,4			○				
223-027700-11EB	CCGW09T304EB2B	9,52	3,97	0,4	2,7	4,4	○						
223-027700-882EB	CCGW09T304EB2B	9,52	3,97	0,4	2,7	4,4			○				
223-027700-11LB	CCGW09T304LB2B	9,52	3,97	0,4	2,7	4,4	○						
223-027700-882LB	CCGW09T304LB2B	9,52	3,97	0,4	2,7	4,4			○				
223-027700-901M	CCGW09T304M2B	9,52	3,97	0,4	2,7	4,4			●				
223-027700-11MB	CCGW09T304MB2B	9,52	3,97	0,4	2,7	4,4	●						
223-027700-882MB	CCGW09T304MB2B	9,52	3,97	0,4	2,7	4,4			●				
223-027700-11N	CCGW09T304N2B	9,52	3,97	0,4	2,7	4,4	○						
223-027700-882N	CCGW09T304N2B	9,52	3,97	0,4	2,7	4,4			○				
223-027700-11NB	CCGW09T304NB2B	9,52	3,97	0,4	2,7	4,4	○						
223-027700-882NB	CCGW09T304NB2B	9,52	3,97	0,4	2,7	4,4			○				
223-027701-11EB	CCGW09T308EB2B	9,52	3,97	0,8	2,6	4,4	○						
223-027701-882EB	CCGW09T308EB2B	9,52	3,97	0,8	2,6	4,4			○				
223-027701-11LB	CCGW09T308LB2B	9,52	3,97	0,8	2,6	4,4	○						
223-027701-882LB	CCGW09T308LB2B	9,52	3,97	0,8	2,6	4,4			○				
223-027701-09LB	CCGW09T308LB2B	9,52	3,97	0,8	2,6	4,4	●						
223-027701-901M	CCGW09T308M2B	9,52	3,97	0,8	2,6	4,4			●				
223-027701-11MB	CCGW09T308MB2B	9,52	3,97	0,8	2,6	4,4	●						
223-027701-882MB	CCGW09T308MB2B	9,52	3,97	0,8	2,6	4,4			●				
223-027701-901HB	CCGW09T308HB2B	9,52	3,97	0,8	2,6	4,4			●				
223-027701-11N	CCGW09T308N2B	9,52	3,97	0,8	2,6	4,4	○						
223-027701-882N	CCGW09T308N2B	9,52	3,97	0,8	2,6	4,4			○				
223-027701-11NB	CCGW09T308NB2B	9,52	3,97	0,8	2,6	4,4	○						
223-027701-882NB	CCGW09T308NB2B	9,52	3,97	0,8	2,6	4,4			○				
223-020054-09M	CCGW120408M2B	12,70	4,76	0,8	2,6	5,5	●						

Turning Inserts CBN | Indexables

Inserts

INSERTS

Turning | CBN

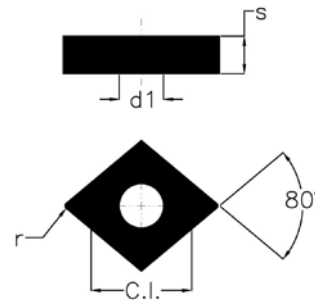

■ Insert solid type CNGG...

● EU Stock - ● Fiudi stock - ○ On demand

EDP	DESCRIPTION	c.i.	s	r	Lt	d1	K		H		Sintered steel		Price
							09	11	901	882	883	879	
							Stock		Stock		Stock		
223-032434-883X3B	CNGG120408X3BBS	12,70	4,76	0,8	12,70	5,16						●	

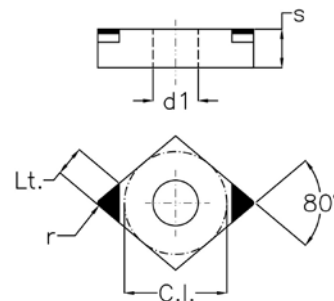
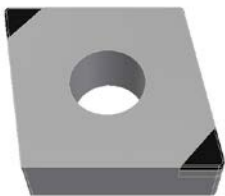

■ Insert two cutting edges type CNGA...

● EU Stock - ● Fiudi stock - ○ On demand

EDP	DESCRIPTION	c.i.	s	r	Lt	d1	K		H		Sintered steel		Price
							09	11	901	882	883	879	
							Stock		Stock		Stock		
223-027051-11LB	CNGA120404LB2B	12,70	4,76	0,4	2,7	5,16		○					
223-027051-882LB	CNGA120404LB2B	12,70	4,76	0,4	2,7	5,16				○			
223-027051-11MB	CNGA120404MB2B	12,70	4,76	0,4	2,7	5,16		●					
223-027051-882MB	CNGA120404MB2B	12,70	4,76	0,4	2,7	5,16				●			
223-027034-11EB	CNGA120408EB2B	12,70	4,76	0,8	2,6	5,16		○					
223-027034-882EB	CNGA120408EB2B	12,70	4,76	0,8	2,6	5,16				○			
223-027034-11LB	CNGA120408LB2B	12,70	4,76	0,8	2,6	5,16		○					
223-027034-882LB	CNGA120408LB2B	12,70	4,76	0,8	2,6	5,16				○			
223-027034-11MB	CNGA120408MB2B	12,70	4,76	0,8	2,6	5,16		●					
223-027034-882MB	CNGA120408MB2B	12,70	4,76	0,8	2,6	5,16				●			
223-027034-09MB	CNGA120408MB2B	12,70	4,76	0,8	2,6	5,16	●						
223-027034-901HB	CNGA120408HB2B	12,70	4,76	0,8	2,6	5,16			●				
223-027034-11N	CNGA120408N2B	12,70	4,76	0,8	2,6	5,16		○					
223-027034-882N	CNGA120408N2B	12,70	4,76	0,8	2,6	5,16				○			
223-027034-11NB	CNGA120408NB2B	12,70	4,76	0,8	2,6	5,16		○					
223-027034-882NB	CNGA120408NB2B	12,70	4,76	0,8	2,6	5,16				○			
223-026483-11E	CNGA120412E2B	12,70	4,76	1,2	2,5	5,16		●					
223-026483-11MB	CNGA120412MB2B	12,70	4,76	1,2	2,5	5,16		●					
223-026483-882MB	CNGA120412MB2B	12,70	4,76	1,2	2,5	5,16				●			
223-026483-11N	CNGA120412N2B	12,70	4,76	1,2	2,5	5,16		○					
223-026483-882N	CNGA120412N2B	12,70	4,76	1,2	2,5	5,16				○			
223-026483-11NB	CNGA120412NB2B	12,70	4,76	1,2	2,5	5,16		○					
223-026483-882NB	CNGA120412NB2B	12,70	4,76	1,2	2,5	5,16				○			



INSERTS

Turning | CBN

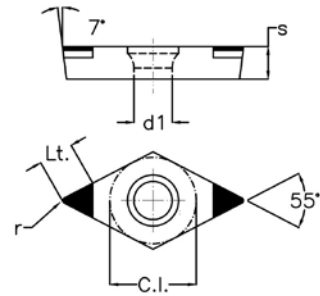
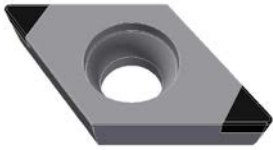

■ Insert two cutting edges type DCGW...

● EU Stock - ● Fiudi stock - ○ On demand

EDP	DESCRIPTION	c.i.	s	r	Lt	d1	K		H		Sintered steel		Price
							09	11	901	882	883	879	
							Stock	Stock	Stock	Stock	Stock	Stock	
224-020055-11LB	DCGW070202LB2B	6,35	2,38	0,2	2,4	2,8	○	○					
224-020055-882LB	DCGW070202LB2B	6,35	2,38	0,2	2,4	2,8	○	○	●				
224-020055-11MB	DCGW070202MB2B	6,35	2,38	0,2	2,4	2,8	○	○					
224-020055-882MB	DCGW070202MB2B	6,35	2,38	0,2	2,4	2,8	○	○					
224-020056-11EB	DCGW070204EB2B	6,35	2,38	0,4	2,2	2,8	○	○					
224-020056-882EB	DCGW070204EB2B	6,35	2,38	0,4	2,2	2,8	○	○					
224-020056-11LB	DCGW070204LB2B	6,35	2,38	0,4	2,2	2,8	○	○					
224-020056-882LB	DCGW070204LB2B	6,35	2,38	0,4	2,2	2,8	○	○					
224-020056-11MB	DCGW070204MB2B	6,35	2,38	0,4	2,2	2,8	○	○					
224-020056-882MB	DCGW070204MB2B	6,35	2,38	0,4	2,2	2,8	○	○	●				
224-020058-11LB	DCGW11T302LB2B	9,52	3,97	0,2	3,1	4,4	○	○					
224-020058-882LB	DCGW11T302LB2B	9,52	3,97	0,2	3,1	4,4	○	○	●				
224-020059-11EB	DCGW11T304EB2B	9,52	3,97	0,4	2,8	4,4	○	○					
224-020059-882EB	DCGW11T304EB2B	9,52	3,97	0,4	2,8	4,4	○	○					
224-020059-11LB	DCGW11T304LB2B	9,52	3,97	0,4	2,8	4,4	○	○	●				
224-020059-882LB	DCGW11T304LB2B	9,52	3,97	0,4	2,8	4,4	○	○					
224-020059-11MB	DCGW11T304MB2B	9,52	3,97	0,4	2,8	4,4	○	○					
224-020059-882MB	DCGW11T304MB2B	9,52	3,97	0,4	2,8	4,4	○	○	●				
224-020059-11N	DCGW11T304N2B	9,52	3,97	0,4	2,8	4,4	○	○					
224-020059-882N	DCGW11T304N2B	9,52	3,97	0,4	2,8	4,4	○	○					
224-020059-11NB	DCGW11T304NB2B	9,52	3,97	0,4	2,8	4,4	○	○					
224-020059-882NB	DCGW11T304NB2B	9,52	3,97	0,4	2,8	4,4	○	○					
224-020060-11EB	DCGW11T308EB2B	9,52	3,97	0,8	2,5	4,4	○	○					
224-020060-882EB	DCGW11T308EB2B	9,52	3,97	0,8	2,5	4,4	○	○					
224-020060-11LB	DCGW11T308LB2B	9,52	3,97	0,8	2,5	4,4	○	○					
224-020060-882LB	DCGW11T308LB2B	9,52	3,97	0,8	2,5	4,4	○	○					
224-020060-901M	DCGW11T308M2B	9,52	3,97	0,8	2,5	4,4	○	○	●				
224-020060-11MB	DCGW11T308MB2B	9,52	3,97	0,8	2,5	4,4	○	○					
224-020060-882MB	DCGW11T308MB2B	9,52	3,97	0,8	2,5	4,4	○	○	●				
224-020060-11N	DCGW11T308N2B	9,52	3,97	0,8	2,5	4,4	○	○					
224-020060-882N	DCGW11T308N2B	9,52	3,97	0,8	2,5	4,4	○	○					
224-020060-11NB	DCGW11T308NB2B	9,52	3,97	0,8	2,5	4,4	○	○					
224-020060-882NB	DCGW11T308NB2B	9,52	3,97	0,8	2,5	4,4	○	○					

Turning Inserts CBN | Indexables

Inserts

INSERTS

Turning | CBN

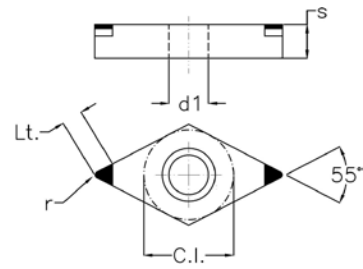
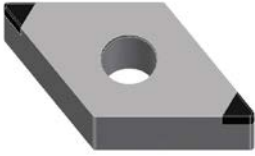

■ Insert two cutting edges type DNGA...

● EU Stock - ● Fiudi stock - ○ On demand

EDP	DESCRIPTION	c.i.	s	r	Lt	d1	K		H		Sintered steel		Price
							09	11	901	882	883	879	
							Stock		Stock		Stock		
224-032197-11MB	DNGA150404MB2B	12,70	4,76	0,4	2,7	5,16	○						
224-032197-882MB	DNGA150404MB2B	12,70	4,76	0,4	2,7	5,16			○				
224-032198-11MB	DNGA150604MB2B	12,70	6,35	0,4	2,7	5,16	●						
224-032198-882MB	DNGA150604MB2B	12,70	6,35	0,4	2,7	5,16			●				
224-026359-11MB	DNGA150608MB2B	12,70	6,35	0,8	2,5	5,16	●						
224-026359-882MB	DNGA150608MB2B	12,70	6,35	0,8	2,5	5,16			●				
224-026359-11N	DNGA150608N2B	12,70	6,35	0,8	2,5	5,16	○						
224-026359-882N	DNGA150608N2B	12,70	6,35	0,8	2,5	5,16			○				
224-026359-901N	DNGA150608N2B	12,70	6,35	0,8	2,5	5,16			●				
224-026359-11NB	DNGA150608NB2B	12,70	6,35	0,8	2,5	5,16	○						
224-026359-882NB	DNGA150608NB2B	12,70	6,35	0,8	2,5	5,16			○				
224-027400-11N	DNGA150612N2B	12,70	6,35	1,2	2,3	5,16	○						
224-027400-882N	DNGA150612N2B	12,70	6,35	1,2	2,3	5,16			○				
224-027400-11NB	DNGA150612NB2B	12,70	6,35	1,2	2,3	5,16	○						
224-027400-882NB	DNGA150612NB2B	12,70	6,35	1,2	2,3	5,16			○				



INSERTS

Turning | CBN

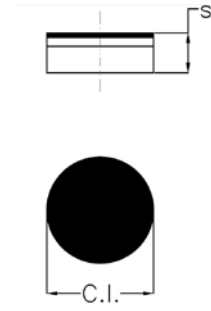

▪ Insert full face type RNGN...

● EU Stock - ● Fiudi stock - ○ On demand

EDP	DESCRIPTION	c.i.	s	r	Lt	d1	K		H		Sintered steel		Price
							09	11	901	882	883	879	
							Stock		Stock		Stock		
231-020072-09E	RNGN120400EBF	12,70	4,76				●						

Turning Inserts CBN | Indexables

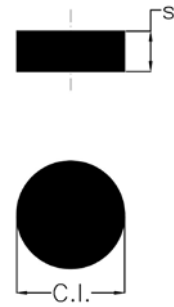

▪ Insert solid type RNGN...

● EU Stock - ● Fiudi stock - ○ On demand

EDP	DESCRIPTION	c.i.	s	r	Lt	d1	K		H		Sintered steel		Price
							09	11	901	882	883	879	
							Stock		Stock		Stock		
251-032435-883X2B	RNGN090300X2BBS	9,52	3,18								●		
251-032435-883X1B	RNGN090300X1BBS	9,52	3,18								●		

Inserts

INSERTS

Turning | CBN

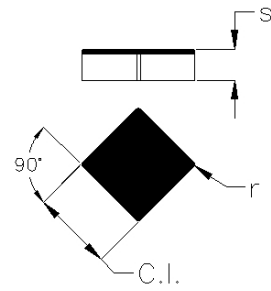

■ Insert full face type SNGN...

● EU Stock - ● Fiudi stock - ○ On demand

EDP	DESCRIPTION	c.i.	s	r	Lt	d1	K		H		Sintered steel		Price
							09	11	901	882	883	879	
							Stock		Stock		Stock		
232-022676-11E	SNGN120408E4BF	12,70	4,76	0,8	12,70		○						
232-022452-11E	SNGN120412E4BF	12,70	4,76	1,2	12,70		●						

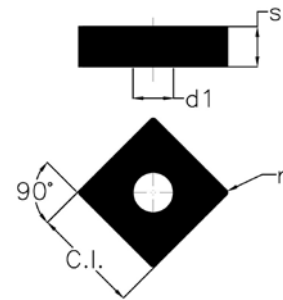

■ Insert solid type SNGG...

● EU Stock - ● Fiudi stock - ○ On demand

EDP	DESCRIPTION	c.i.	s	r	Lt	d1	K		H		Sintered steel		Price
							09	11	901	882	883	879	
							Stock		Stock		Stock		
252-033368-883M	SNGG120408M8BS	12,70	4,76	0,8	12,70	5,16					○		
252-033369-883M	SNGG120412M8BS	12,70	4,76	1,2	12,70	5,16					○		

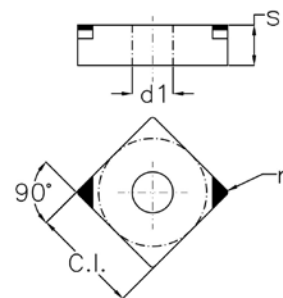

■ Insert two cutting edges type SNGA...

● EU Stock - ● Fiudi stock - ○ On demand

EDP	DESCRIPTION	c.i.	s	r	Lt	d1	K		H		Sintered steel		Price
							09	11	901	882	883	879	
							Stock		Stock		Stock		
232-032199-11MB	SNGA120408MB2B	12,70	4,76	0,8	2,6	5,16		○					
232-032199-09MB	SNGA120408MB2B	12,70	4,76	0,8	2,6	5,16	○						
232-032200-11MB	SNGA120412MB2B	12,70	4,76	1,2	2,5	5,16		○					
232-032200-09MB	SNGA120412MB2B	12,70	4,76	1,2	2,5	5,16	○						

INSERTS

Turning | CBN

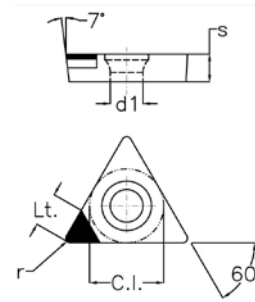

■ Insert one cutting edge type TCGW...

● EU Stock - ● Fiudi stock - ○ On demand

EDP	DESCRIPTION	c.i.	s	r	Lt	d1	K		H		Sintered steel		Price
							09	11	901	882	883	879	
							Stock	Stock	Stock	Stock	Stock	Stock	
213-033041-11LB	TCGW090202LB1B	5,56	2,38	0,2	3	2,8	○						
213-033041-882LB	TCGW090202LB1B	5,56	2,38	0,2	3	2,8			●				
213-032201-11MB	TCGW110204MB1B	6,35	2,38	0,4	3	2,8	●						
213-032201-882MB	TCGW110204MB1B	6,35	2,38	0,4	3	2,8				●			
213-032202-901M	TCGW110208M1B	6,35	2,38	0,8	2,8	2,8			●				
213-032202-11MB	TCGW110208MB1B	6,35	2,38	0,8	2,8	2,8	●						
213-032202-882MB	TCGW110208MB1B	6,35	2,38	0,8	2,8	2,8				●			
213-032202-09MB	TCGW110208MB1B	6,35	2,38	0,8	2,8	2,8				●			
213-032202-09HB	TCGW110208HB1B	6,35	2,38	0,8	2,8	2,8	●						
213-032202-882NB	TCGW110208NB1B	6,35	2,38	0,8	2,8	2,8				○			
213-032204-11MB	TCGW16T304MB1B	9,52	3,97	0,4	3	4,4		○					
213-032204-882MB	TCGW16T304MB1B	9,52	3,97	0,4	3	4,4				○			
213-032205-11MB	TCGW16T308MB1B	9,52	3,97	0,8	2,8	4,4		○					
213-032205-882MB	TCGW16T308MB1B	9,52	3,97	0,8	2,8	4,4				○			
213-032205-09MB	TCGW16T308MB1B	9,52	3,97	0,8	2,8	4,4	●						

Turning Inserts CBN | Indexables

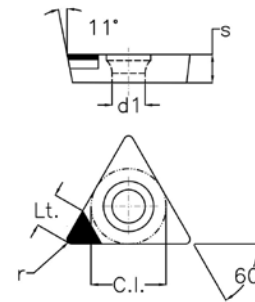

■ Insert one cutting edge type TPGW...

● EU Stock - ● Fiudi stock - ○ On demand

EDP	DESCRIPTION	c.i.	s	r	Lt	d1	K		H		Sintered steel		Price
							09	11	901	882	883	879	
							Stock	Stock	Stock	Stock	Stock	Stock	
213-032206-11MB	TPGW090204MB1B	5,56	2,38	0,4	3	2,8	○						
213-032206-882MB	TPGW090204MB1B	5,56	2,38	0,4	3	2,8				○			
213-032207-11MB	TPGW110304MB1B	6,35	3,18	0,4	3	2,8	○						
213-032207-882MB	TPGW110304MB1B	6,35	3,18	0,4	3	2,8				○			
213-032208-11MB	TPGW110308MB1B	6,35	3,18	0,8	2,8	2,8	○						
213-032208-882MB	TPGW110308MB1B	6,35	3,18	0,8	2,8	2,8				○			

Inserts

INSERTS

Turning | CBN

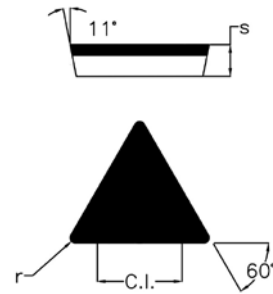
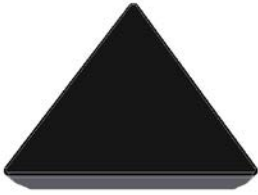

■ Insert full face type TPGN...

● EU Stock - ● Fiudi stock - ○ On demand

EDP	DESCRIPTION	c.i.	s	r	Lt	d1	K		H		Sintered steel		Price
							09	11	901	882	883	879	
							Stock		Stock		Stock		
233-033372-11E	TPGN110304EB3BF	6,35	3,18	0,4	11			○					
233-033373-11E	TPGN110308EB3BF	6,35	3,18	0,8	11			○					

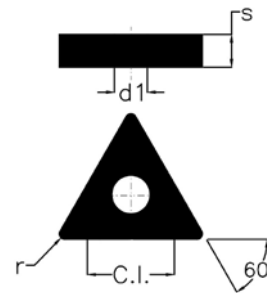
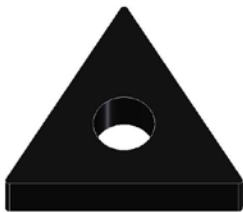

■ Insert solid type TNGG...

● EU Stock - ● Fiudi stock - ○ On demand

EDP	DESCRIPTION	c.i.	s	r	Lt	d1	K		H		Sintered steel		Price
							09	11	901	882	883	879	
							Stock		Stock		Stock		
253-033371-883M	TNGG160408M6BS	9,52	4,76	0,8	3,7	4,4					○		

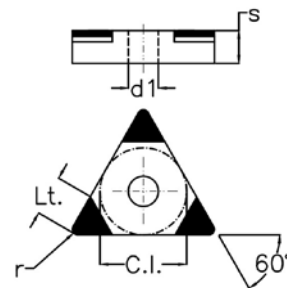
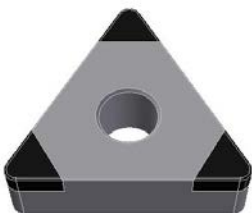

■ Insert three cutting edges type TNGA...

● EU Stock - ● Fiudi stock - ○ On demand

EDP	DESCRIPTION	c.i.	s	r	Lt	d1	K		H		Sintered steel		Price
							09	11	901	882	883	879	
							Stock		Stock		Stock		
233-027694-11MB	TNGA160404MB3B	9,52	4,76	0,4	3,7	4,4		●					
233-027694-882MB	TNGA160404MB3B	9,52	4,76	0,4	3,7	4,4				●			
233-027695-11MB	TNGA160408MB3B	9,52	4,76	0,8	3,5	4,4		●					
233-027695-882MB	TNGA160408MB3B	9,52	4,76	0,8	3,5	4,4				●			
233-027695-882HB	TNGA160408HB3B	9,52	4,76	0,8	3,5	4,4				●			
233-027696-11MB	TNGA160412MB3B	9,52	4,76	1,2	3,2	4,4		○					
233-027696-882MB	TNGA160412MB3B	9,52	4,76	1,2	3,2	4,4				○			



INSERTS

Turning | CBN

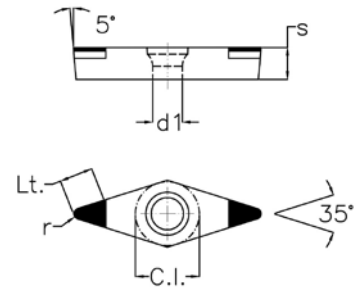
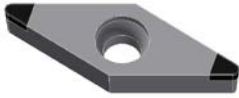

■ Insert two cutting edges type VBGW...

● EU Stock - ● Fiudi stock - ○ On demand

EDP	DESCRIPTION	c.i.	s	r	Lt	d1	K		H		Sintered steel		Price
							09	11	901	882	883	879	
							Stock		Stock		Stock		
236-032209-11LB	VBGW160402LB2B	9,52	4,76	0,2	4,3	4,4		○					
236-032209-882LB	VBGW160402LB2B	9,52	4,76	0,2	4,3	4,4				●			
236-032209-11MB	VBGW160402MB2B	9,52	4,76	0,2	4,3	4,4		○					
236-032209-882MB	VBGW160402MB2B	9,52	4,76	0,2	4,3	4,4					○		
236-027714-11L	VBGW160404L2B	9,52	4,76	0,4	4,1	4,4		○					
236-027714-11LB	VBGW160404LB2B	9,52	4,76	0,4	4,1	4,4		○					
236-027714-882LB	VBGW160404LB2B	9,52	4,76	0,4	4,1	4,4					○		
236-027714-11MB	VBGW160404MB2B	9,52	4,76	0,4	4,1	4,4		●					
236-027714-882MB	VBGW160404MB2B	9,52	4,76	0,4	4,1	4,4					●		
236-027715-11LB	VBGW160408LB2B	9,52	4,76	0,8	3,3	4,4		○					
236-027715-882LB	VBGW160408LB2B	9,52	4,76	0,8	3,3	4,4					○		
236-027715-11MB	VBGW160408MB2B	9,52	4,76	0,8	3,3	4,4		●					
236-027715-882MB	VBGW160408MB2B	9,52	4,76	0,8	3,3	4,4					●		

Turning Inserts CBN | Indexables

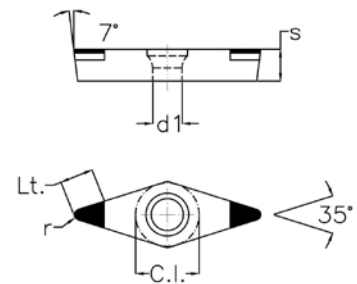
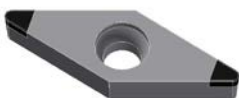

■ Insert two cutting edges type VCGW...

● EU Stock - ● Fiudi stock - ○ On demand

EDP	DESCRIPTION	c.i.	s	r	Lt	d1	K		H		Sintered steel		Price
							09	11	901	882	883	879	
							Stock		Stock		Stock		
236-027723-11LB	VCGW160404LB2B	9,52	4,76	0,4	4,1	4,4		○					
236-027723-882LB	VCGW160404LB2B	9,52	4,76	0,4	4,1	4,4					○		
236-027723-11MB	VCGW160404MB2B	9,52	4,76	0,4	4,1	4,4		○					
236-027723-882MB	VCGW160404MB2B	9,52	4,76	0,4	4,1	4,4					○		
236-027724-11LB	VCGW160408LB2B	9,52	4,76	0,8	3,3	4,4		○					
236-027724-882LB	VCGW160408LB2B	9,52	4,76	0,8	3,3	4,4					○		
236-027724-11MB	VCGW160408MB2B	9,52	4,76	0,8	3,3	4,4		○					
236-027724-882MB	VCGW160408MB2B	9,52	4,76	0,8	3,3	4,4					○		

Inserts

INSERTS

Turning | CBN

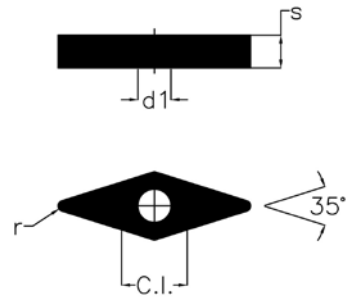

■ Insert solid type VNGG...

● EU Stock - ● Fiudi stock - ○ On demand

EDP	DESCRIPTION	c.i.	s	r	Lt	d1	K		H		Sintered steel		Price	
							09	11	901	882	883	879		
							Stock		Stock		Stock			
256-032446-883X4B	VNGG160408X4BBS	9,52	4,76	0,8	3,3	3,81								

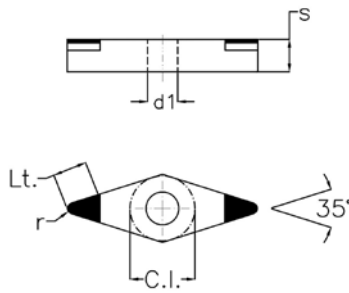

■ Insert two cutting edges type VNGA...

● EU Stock - ● Fiudi stock - ○ On demand

EDP	DESCRIPTION	c.i.	s	r	Lt	d1	K		H		Sintered steel		Price
							09	11	901	882	883	879	
							Stock		Stock		Stock		
236-027347-11MB	VNGA160404MB2B	9,52	4,76	0,4	4,1	3,81		○					
236-027347-882MB	VNGA160404MB2B	9,52	4,76	0,4	4,1	3,81							
236-026172-11MB	VNGA160408MB2B	9,52	4,76	0,8	3,3	3,81		●					
236-026172-882MB	VNGA160408MB2B	9,52	4,76	0,8	3,3	3,81							

Turning Inserts CBN | Indexables

Inserts

INSERTS

Turning | CBN

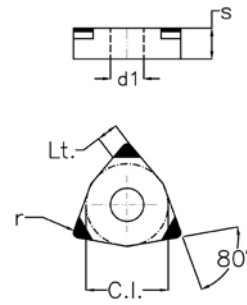
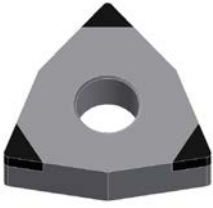

■ Insert three cutting edges type WNGA...

● EU Stock - ● Fiudi stock - ○ On demand

EDP	DESCRIPTION	c.i.	s	r	Lt	d1	K		H		Sintered steel		Price
							09	11	901	882	883	879	
							Stock	Stock	Stock	Stock	Stock	Stock	
234-032211-11MB	WNGA080404MB3B	12,7	4,76	0,4	2,9	5,13	○						
234-032211-882MB	WNGA080404MB3B	12,7	4,76	0,4	2,9	5,13				●			
234-032212-11MB	WNGA080408MB3B	12,7	4,76	0,8	2,8	5,13	○						
234-032212-882MB	WNGA080408MB3B	12,7	4,76	0,8	2,8	5,13				●			
234-032212-11N	WNGA080408N3B	12,7	4,76	0,8	2,8	5,13	○						
234-032212-882N	WNGA080408N3B	12,7	4,76	0,8	2,8	5,13				○			
234-032212-11NB	WNGA080408NB3B	12,7	4,76	0,8	2,8	5,13	○						
234-032212-882NB	WNGA080408NB3B	12,7	4,76	0,8	2,8	5,13				○			
234-032214-11MB	WNGA080412MB3B	12,7	4,76	1,2	2,7	5,13	○						
234-032214-882MB	WNGA080412MB3B	12,7	4,76	1,2	2,7	5,13				○			
234-032214-11N	WNGA080412N3B	12,7	4,76	1,2	2,7	5,13	○						
234-032214-882N	WNGA080412N3B	12,7	4,76	1,2	2,7	5,13				○			
234-032214-11NB	WNGA080412NB3B	12,7	4,76	1,2	2,7	5,13	○						
234-032214-882NB	WNGA080412NB3B	12,7	4,76	1,2	2,7	5,13				○			

Turning Inserts CBN | Indexables

Inserts



















CUTTING CONDITIONS CBN

Turning | Indexables | Cutting Conditions

INSERTS CBN

Cutting Conditions

Work material	Application	Coolant	Quality	Cutting Conditions		
				Ap (mm)	F (mm/rev)	Vc (m/min)
K Grey cast iron			09	0,10 - 0,30 - 1,00	0,10 - 0,20 - 0,50	500 - 1500 - 2000
			11	0,10 - 0,30 - 1,00	0,10 - 0,25 - 0,60	400 - 1200 - 1600
			09	0,10 - 0,20 - 0,50	0,10 - 0,20 - 0,40	200 - 350 - 500
			11	0,10 - 0,20 - 0,50	0,10 - 0,30 - 0,50	150 - 300 - 450
NIHard cast iron			883	0,10 - 0,20 - 0,50	0,10 - 0,30 - 0,50	200 - 350 - 500
			882	0,05 - 0,15 - 0,20	0,03 - 0,10 - 0,15	100 - 180 - 300
H Hardened steel			901	0,05 - 0,20 - 0,35	0,03 - 0,10 - 0,30	50 - 100 - 150
			883	0,05 - 0,20 - 0,35	0,03 - 0,10 - 0,30	60 - 150 - 200
			879	0,05 - 0,15 - 0,25	0,03 - 0,10 - 0,20	50 - 150 - 250
H Sintered steel			879	0,05 - 0,15 - 0,25	0,03 - 0,10 - 0,20	50 - 120 - 220

1. Above info are to be considered as general guidelines. Modifications may be necessary according actual working conditions.
2. Check the correct positioning of the insert on tool holder before use

Turning Inserts CBN | Indexables

ABRASIVE QUALITY

Technical specification

Quality	Technical Specification	% Abrasive	Hardness Hv
882	The sub-micrometric grain size makes it suitable for finishing operations on hardened steels in continuous or slightly interrupted cut. High thermal stability.	> 60 %	2500 - 2700
901	Composed by sub-micrometric particle size, suitable for finishing operations on hardened steels with strongly interrupted cut with an adequate cutting edge preparation.	< 60 %	2600 - 2800
09	The size of the CBN grains makes this grade particularly resistant to wear, suitable for finishing operations on Grey cast iron, on continuous cut and/or in presence of slightly interrupted cut.	< 90 %	3700 - 3900
11	The size of the grain of this CBN abrasive together with its bond characteristics grant a good toughness and surface finishing machining on grey cast iron in presence of interrupted cut.	< 85 %	3600 - 3800
879	The size of the CBN grains of this abrasive maximizes its wear resistance, particularly suitable for machining sintered steel at high speed.	< 90 %	3700 - 3900
883	Solid CBN particularly recommended for heavy duty, high thermal conductivity, excellent wear resistance.	< 90 %	3750 - 3950

Cutting Conditions

CUTTING CONDITIONS CBN

Turning | Indexables | Cutting Conditions

SELECTION OF ABRASIVE QUALITY

Application and surface finishing

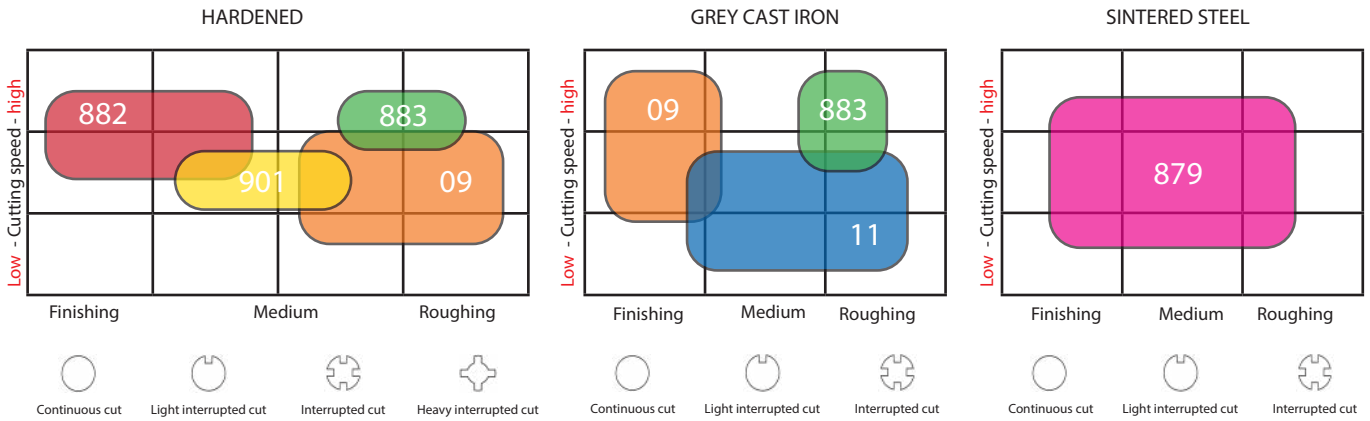

MICROGEOMETRY OF CUTTING EDGE

Technical specification

MICROGEOMETRY OF CUTTING EDGE		
Letter	DESCRIPTION	Scheme
F	Sharp edge	
E	Honed cutting edge	
L	0,1 x15° Chamfered cutting edge	
M	0,13 x25° Chamfered cutting edge	
H	0,13 x35° Chamfered cutting edge	
N	0,25 x35° Chamfered cutting edge	

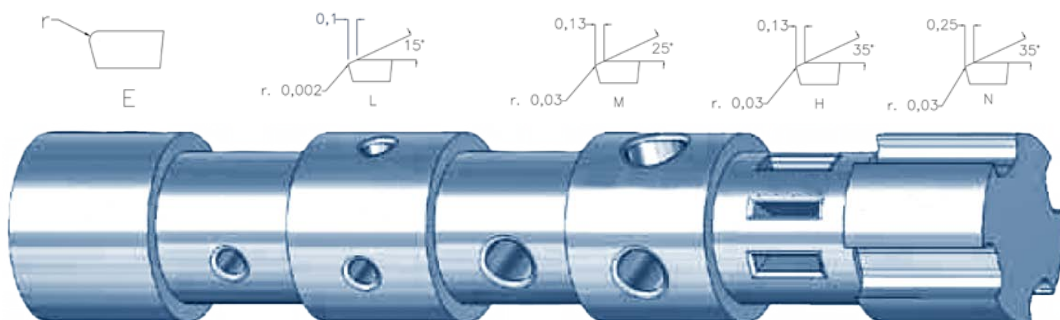

INSERTS

Turning | PCD

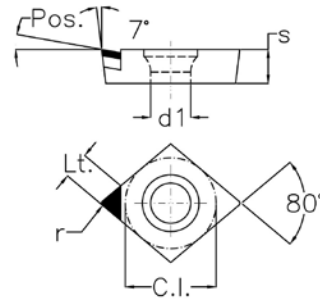
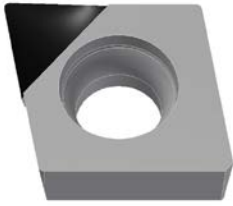

■ Insert single cutting edge type CCGT...

● EU Stock - ● Fiudi stock - ○ On demand

EDP	DESCRIPTION	c.i.	s	r	Lt	d1	N				CFRP	Price	
							55	57	66	69			66
							Stock	Stock	Stock	Stock			Stock
203-032175-57	CCGT060202F1P	6,35	2,38	0,2	3,3	2,8		●					
203-032176-57	CCGT060204F1P	6,35	2,38	0,4	3,2	2,8		●					
203-032177-57	CCGT060208F1P	6,35	2,38	0,8	3,1	2,8		○					
203-033374-57	CCGT09T304F1P	9,52	3,97	0,4	4,1	4,4		●					
203-033375-57	CCGT09T308F1P	9,52	3,97	0,8	4,0	4,4		○					
203-033376-57	CCGT120404F1P	12,70	4,76	0,4	6,0	5,5		●					
203-033377-57	CCGT120408F1P	12,70	4,76	0,8	5,9	5,5		○					

Turning Inserts PCD | Indexables

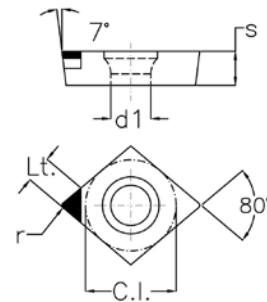
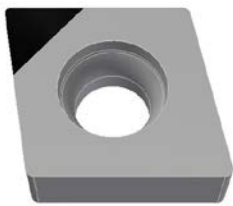

■ Insert single cutting edge type CCGW...

● EU Stock - ● Fiudi stock - ○ On demand

EDP	DESCRIPTION	c.i.	s	r	Lt	d1	N				CFRP	Price	
							55	57	66	69			66
							Stock	Stock	Stock	Stock			Stock
203-020101-57	CCGW060202F1P	6,35	2,38	0,2	3,3	2,8		●					
203-020102-55	CCGW060204F1P	6,35	2,38	0,4	3,2	2,8	●						
203-020102-66	CCGW060204F1P	6,35	2,38	0,4	3,2	2,8			●		●		
203-020103-55	CCGW060208F1P	6,35	2,38	0,8	3,1	2,8	●						
203-032178-55	CCGW09T304F1P	9,52	3,97	0,4	4,1	4,4	●						
203-032178-57	CCGW09T304F1P	9,52	3,97	0,4	4,1	4,4		●					
203-032179-57	CCGW09T308F1P	9,52	3,97	0,8	4,0	4,4		●					
203-032180-57	CCGW120404F1P	12,70	4,76	0,4	6,0	5,5		●					
203-032181-55	CCGW120408F1P	12,70	4,76	0,8	5,9	5,5	●						
203-032181-57	CCGW120408F1P	12,70	4,76	0,8	5,9	5,5		○					

Inserts

INSERTS

Turning | PCD

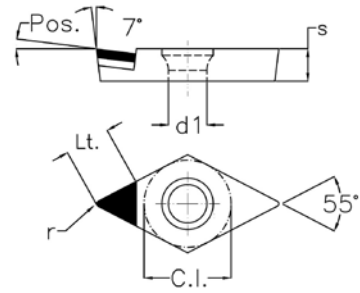
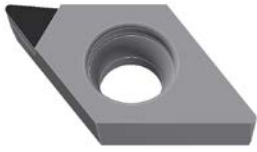

▪ Insert single cutting edge type DCGT...

● EU Stock - ● Fiudi stock - ○ On demand

EDP	DESCRIPTION	c.i.	s	r	Lt	d1	N					Price
											CFRP	
							55	57	66	69	66	
							Stock	Stock	Stock			
204-033378-57	DCGT070202F1P	6,35	2,38	0,2	3,9	2,8		●				
204-033379-57	DCGT070204F1P	6,35	2,38	0,4	3,7	2,8		●				
204-022580-57	DCGT11T304F1P	9,52	3,97	0,4	4,2	4,4		●				
204-033380-57	DCGT11T308F1P	9,52	3,97	0,8	3,9	4,4		○				

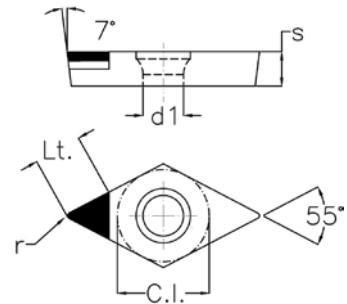
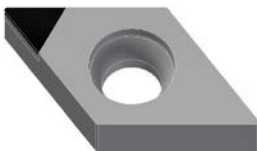

▪ Insert single cutting edge type DCGW...

● EU Stock - ● Fiudi stock - ○ On demand

EDP	DESCRIPTION	c.i.	s	r	Lt	d1	N					Price
											CFRP	
							55	57	66	69	66	
							Stock	Stock	Stock			
204-032182-57	DCGW070202F1P	6,35	2,38	0,2	3,9	2,8		●				
204-032183-55	DCGW070204F1P	6,35	2,38	0,4	3,7	2,8		●				
204-032184-55	DCGW11T304F1P	9,52	3,97	0,4	4,2	4,4		●				
204-032185-55	DCGW11T308F1P	9,52	3,97	0,8	3,9	4,4		●				
204-032185-57	DCGW11T308F1P	9,52	3,97	0,8	3,9	4,4		●				

INSERTS

Turning | PCD

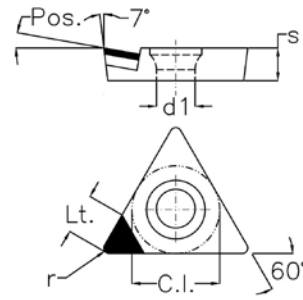

■ Insert single cutting edge type TCGT...

● EU Stock - ● Fiudi stock - ○ On demand

EDP	DESCRIPTION	c.i.	s	r	Lt	d1	N					CFRP	Price
							55	57	66	69	66		
							Stock		Stock		Stock		
213-028932-55	TCGT090208F1P	5,56	2,38	0,8	3	2,5	○						
213-033381-57	TCGT110204F1P	6,35	2,38	0,4	3,7	2,8		●					
213-033382-57	TCGT16T304F1P	9,52	3,97	0,4	5,7	4,4		○					

Turning Inserts PCD | Indexables

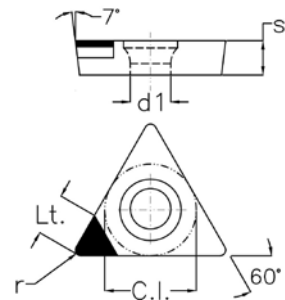

■ Insert single cutting edge type TCGW...

● EU Stock - ● Fiudi stock - ○ On demand

EDP	DESCRIPTION	c.i.	s	r	Lt	d1	N					CFRP	Price
							55	57	66	69	66		
							Stock		Stock		Stock		
213-020088-55	TCGW090204F1P	5,56	2,38	0,4	3,3	2,5	●						
213-032186-55	TCGW090208F1P	5,56	2,38	0,8	2,7	2,5	●						
213-032187-55	TCGW110204F1P	6,35	2,38	0,4	3,7	2,8	●						
213-032188-55	TCGW16T304F1P	9,52	3,97	0,4	5,7	4,4	●						
213-032189-55	TCGW16T308F1P	9,52	3,97	0,8	5,4	4,4	●						

Inserts

INSERTS

Turning | PCD

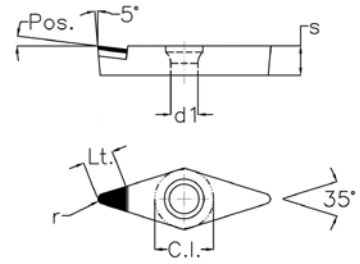
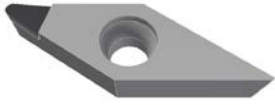

▪ Insert single cutting edge type VBGT...

● EU Stock - ● Fiudi stock - ○ On demand

EDP	DESCRIPTION	c.i.	s	r	Lt	d1	N				CFRP	Price
							55	57	66	69		
							Stock		Stock			
216-032260-55	VBGT160404F1P	9,52	4,76	0,4	5,7	4,4	●					
216-032261-57	VBGT160408F1P	9,52	4,76	0,8	4,9	4,4		○				

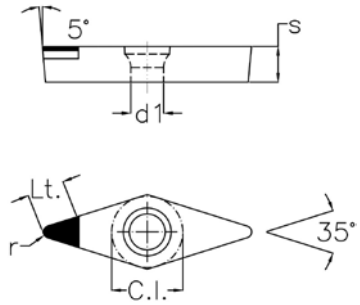

▪ Insert single cutting edge type VBGW...

● EU Stock - ● Fiudi stock - ○ On demand

EDP	DESCRIPTION	c.i.	s	r	Lt	d1	N				CFRP	Price
							55	57	66	69		
							Stock		Stock			
216-032602-57	VBGW160402F1P	9,52	4,76	0,2	6,3	4,4		●				
216-032190-55	VBGW160404F1P	9,52	4,76	0,4	5,7	4,4	●					
216-032190-57	VBGW160404F1P	9,52	4,76	0,4	5,7	4,4		●				
216-032191-57	VBGW160408F1P	9,52	4,76	0,8	4,9	4,4		●				
216-032191-66	VBGW160408F1P	9,52	4,76	0,8	4,9	4,4			●		●	

INSERTS

Turning | PCD

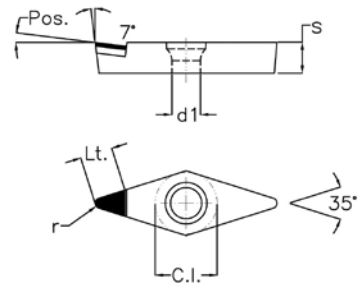
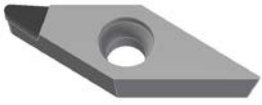

■ Insert single cutting edge type VCGT...

● EU Stock - ● Fiudi stock - ○ On demand

EDP	DESCRIPTION	c.i.	s	r	Lt	d1	N					CFRP	Price
							55	57	66	69	66		
							Stock	Stock	Stock	Stock	Stock		
216-033383-57	VCGT110304F1P	6,35	3,18	0,4	4,0	2,8		●					
216-033365-55	VCGT160404F1P	9,52	4,76	0,4	5,7	4,4	●						
216-033365-57	VCGT160404F1P	9,52	4,76	0,4	5,7	4,4		○					
216-032010-57	VCGT160408F1P	9,52	4,76	0,8	4,9	4,4		○					

Turning Inserts PCD | Indexables

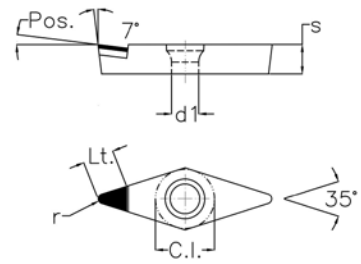
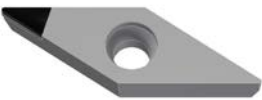

■ Insert single cutting edge type VCGW...

● EU Stock - ● Fiudi stock - ○ On demand

EDP	DESCRIPTION	c.i.	s	r	Lt	d1	N					CFRP	Price
							55	57	66	69	66		
							Stock	Stock	Stock	Stock	Stock		
216-032192-69	VCGW110304F1P	6,35	3,18	0,4	4,0	2,8				●			
216-032192-57	VCGW110304F1P	6,35	3,18	0,4	4,0	2,8		●					
216-032193-57	VCGW160404F1P	9,52	4,76	0,4	5,7	4,4		●					
216-032194-55	VCGW160408F1P	9,52	4,76	0,8	4,9	4,4	●						

Inserts

INSERTS

Turning | PCD

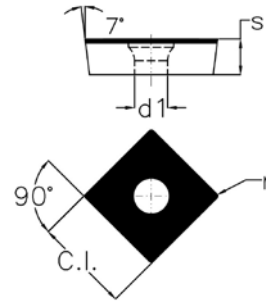

■ Insert full face type SCGW...

● EU Stock - ● Fiudi stock - ○ On demand

EDP	DESCRIPTION	c.i.	s	r	Lt	d1	N				CFRP	Price	
							55	57	66	69			66
							Stock	Stock	Stock	Stock			Stock
232-027090-57	SCGW120404F4PF	12,70	4,76	0,4	12,70	5,5		○					
232-016485-57	SCGW120408F4PF	12,70	4,76	0,8	12,70	5,5		○					

Turning Inserts PCD | Indexables

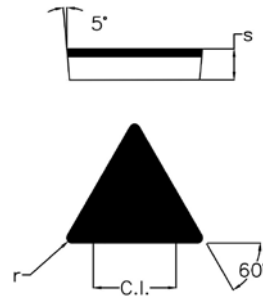
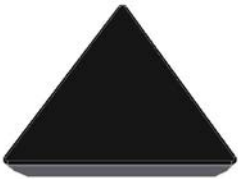

■ Insert full face type TBGN...

● EU Stock - ● Fiudi stock - ○ On demand

EDP	DESCRIPTION	c.i.	s	r	Lt	d1	N				CFRP	Price	
							55	57	66	69			66
							Stock	Stock	Stock	Stock			Stock
233-020116-57	TBGN060104F3PF	3,97	1,59	0,4	6,9			○					

Inserts

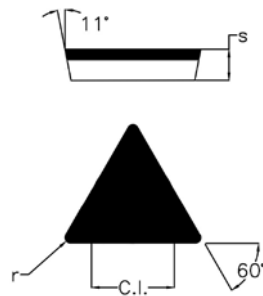

■ Insert full face type TPGN...

● EU Stock - ● Fiudi stock - ○ On demand

EDP	DESCRIPTION	c.i.	s	r	Lt	d1	N				CFRP	Price	
							55	57	66	69			66
							Stock	Stock	Stock	Stock			Stock
233-020121-57	TPGN110304F3PF	11	3,18	0,4	11			●					
213-020082-57	TPGN110308F3PF	11	3,18	0,8	11			○					

CUTTING CONDITIONS PCD

Turning | Indexables | Cutting Conditions

INSERTS PCD

Cutting Conditions

	Work material	Application	Quality	Cutting conditions		
				Ap (mm)	F (mm/rev)	Vc (m/min)
N	Aluminium (AISI 1-8%)	Finishing / semi-finishing	57	0,03 - 12	0,12 - 0,20 - 0,30	1000 - 3500 - 6000
	Aluminium (AISI 6-12%)	Finishing / semi-finishing	57	0,03 - 12	0,12 - 0,20 - 0,30	800 - 1900 - 3000
	Aluminium (AISI >12%)	Roughing	66	0,03 - 5	0,10 - 0,15 - 0,20	200 - 600 - 1000
	Brass - Bronze - Copper	Finishing / semi-finishing	57	0,03 - 3	0,10 - 0,17 - 0,25	800 - 1000 - 1200
CFRP	Composite CFRP	Finishing / semi-finishing	66	0,03 - 12	0,05 - 0,10 - 0,15	200 - 400 - 600

- Above info are to be considered as general guidelines. Modifications may be necessary according actual working conditions.
- Check the correct positioning of the insert on tool holder before use

ABRASIVE QUALITY

Technical specification

Quality	Technical specification
69	Diamond sub-micrometric grain size is recommended for finishing operation on aluminium and light alloy materials in general. It guarantee a good surface finishing (Ra)
55	Diamond size with intermediate propertries between quality 57 and 69, recommended to grant special profiles. High wear resistance.
57	Diamond grain average size makes it suitable for multi-applications balancing good quality surface finishing and high wear resistance.
66	Bimodal diamond grain size guarantees an excellent wear resistance improving tool life. Particularly recommended for roughing operation.

CHIP SHAPE

Optimal chip evacuation

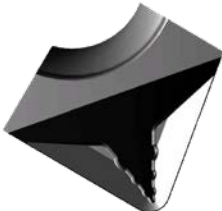
	Technical specifications
	<p>Made for machining aluminium alloys in finishing operation. Obtained geometry is able to control chip with a minimum depth of cut $A_p = 0,10$ mm/rev. Designed to deform chip whose section is extremely reduced, so that it can break to acceptable lenght avoiding to wdamage surface already machined. Being a special profile whose realization requires the knowledge of: Material to machine, Insert angle of approach and machining direction, Depth of cut (A_p), feed rate (f)</p>

SELECTION OF QUALITY

Quality and Applications

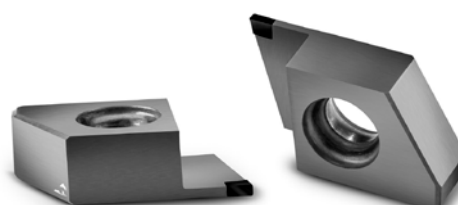
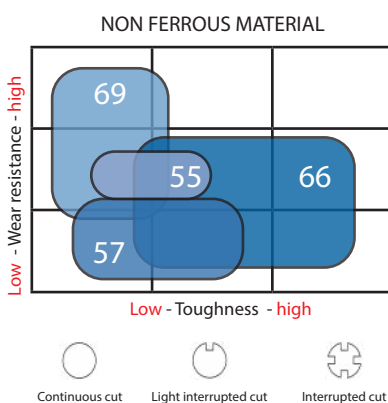

SWEDEN

Branch office of OSG SCANDINAVIA
Singelgatan 7
212 28 Malmö
Sweden
Tel: +46 40 41 22 55
osg@osg-scandinavia.com

OSG SCANDINAVIA

(For Scandinavian countries)
Langebjergrvaenget 16
4000 Roskilde
Denmark
Tel: +45 46 75 65 55
osg@osg-scandinavia.com

OSG NETHERLANDS

Bedrijfweg 5
3481 MG Harmelen
The Netherlands
Tel: +31 348 44 2764
Fax: +31 348 44 2144
info@osg-nl.com

OSG UK

Kelsey Close, Attleborough Fields Ind Est,
CV11 6RS, Nuneaton
United Kingdom
Tel: +44 1827 720 013
sales@osg-uk.com

OSG EUROPE LOGISTICS

Avenue Lavoisier 1
B-1300 Z.I. Wavre - Nord
Belgium
Tel: +32 10 23 05 07
Fax: +32 10 23 05 51
info@osgeurope.com

OSG BELUX

Avenue Lavoisier 1
B-1300 Z.I. Wavre - Nord
Belgium
Tel: +32 10 23 05 11
Fax: +32 10 23 05 31
info@osg-belgium.com

OSG IBÉRICA

Bekolarra 4
E - 01010 Vitoria-Gasteiz
Spain
Tel: +34 945 242 400
Fax: +34 945 228 883
osg.iberica@osg-ib.com

OSG FRANCE

Parc Icade, Paris Nord 2
Immeuble "Le Rimbaud"
22 Avenue des Nations
CS66191 - 93420 Villepinte
France
Tel: +33 1 49 90 10 10
Fax: +33 1 49 90 10 15
sales@osg-france.com

OSG ITALY

Via Ferrero, 65 A/B
I - 10098 Rivoli
Italy
Tel: +39 0117705211
Fax: +39 0117705215
info@osg-italia.it





CZECH REPUBLIC, SLOVAKIA, HUNGARY

OSG Europe Logistics S.A.
Slovakia, organizačná zložka
Račianska 22/A, Bratislava 831 02
Slovakia
Tel.: +421 24 32 91 295
info@osgeurope.com

OSG POLAND

ul. Spółdzielcza 57
05-074 Halinów
Polska
Tel: +22 760 82 71
Mob. +48 570 677 711
osg@osg-poland.com

OSG RUSSIA

Butlerova street, 17B, office 5069
117342 Moscow
Russia
Tel: +7 (495) 150 41 54
info@osg-russia.com

ROMSAN INTERNATIONAL CO. SRL

Reprezentant Exclusiv OSG
25C, Bucuresti-Magurele Street
051431 Bucuresti
România
Tel: +40 21 322 07 47
Fax: +40 21 321 56 00
romsan.int@romsan.ro

OSG TURKEY

Rami Kışla Cad.No:56 Eyüp
Istanbul 34056
Turkey
Tel: +90 212 565 24 00
Fax: +90 212 565 44 00
info@osg-turkey.com

Vischer & Bolli AG

Machining and Workholding
Im Schossacher 17
CH-8600 Dübendorf
Schweiz
Tel.: +41 44 802 15 15
Fax: +41 44 802 15 95
info@vb-tools.com

OSG GERMANY

Karl-Ehmann-Str. 25
D - 73037 Göppingen
Germany
Tel: +49 7161 6064 - 0
Fax: +49 7161 6064 - 444
info@osg-germany.de



shaping your dreams

OSG EUROPE LOGISTICS

Avenue Lavoisier 1
B-1300 Z.I. Wavre - Nord - Belgium
Tel: +32 10 23 05 07
Fax: +32 10 23 05 51
info@osgeurope.com

OSG BELUX

Avenue Lavoisier 1
B-1300 Z.I. Wavre - Nord - Belgium
Tel: +32 10 23 05 11
Fax: +32 10 23 05 31
info@osg-belgium.com

OSG FRANCE

Parc Icade, Paris Nord 2
Immeuble "Le Rimbaud"
22 Avenue des Nations
CS66191 - 93420 Villepinte - France
Tel: +33 1 49 90 10 10
Fax: +33 1 49 90 10 15
sales@osg-france.com

OSG NETHERLANDS

Bedrijfsweg 5 - 3481 MG Harmelen
Tel: +31 348 44 2764
Fax: +31 348 44 2144
info@osg-nl.com

OSG UK

Kelsey Close, Attleborough Fields Ind Est,
CV11 6RS, Nuneaton, United Kingdom.
Tel: +44 1827 720 013
uk_sales@osg-uk.com

CZECH, SLOVAKIA, HUNGARY

OSG Europe Logistics S.A.
Slovakia organizacna zlozka
Racianská 22/A, SK-83102 Bratislava
Slovakia
Tel. +421 24 32 91 295
Orders-osgsvk@osgeurope.com

OSG POLAND Sp. z.o.o.

Spółdzielcza 57
05-074 Halinów - Poland
Tel: +22 760 82 71
Fax: +22 760 82 71
osg@osg-poland.com

OSG GERMANY

Karl-Ehmann-Str. 25
D - 73037 Göppingen - Germany
Tel: +49 7161 6064 - 0
Fax: +49 7161 6064 - 444
info@osg-germany.de

OSG SCANDINAVIA

(For Scandinavian countries)
Langebjergvaenget 16
4000 Roskilde - Denmark
Tel: +45 46 75 65 55
Fax: +45 46 75 67 00
osg@osg-scandinavia.com

SWEDEN

Branch office of OSG SCANDINAVIA
Singelgatan 7
212 28 Malmö - Sweden
Tel: +46 40 41 22 55
osg@osg-scandinavia.com

OSG IBERICA

Bekolarra 4
E - 01010 Vitoria-Gasteiz - Spain
Tel: +34 945 242 400
Fax: +34 945 228 883
osg.iberica@osg-ib.com

RUSSIA

Butlerova street, 17B, office 5069
117342 Moscow - Russia
Tel: +7 (495) 150 41 54
info@osg-russia.com

OSG TURKEY

Rami Kişla Cad.No:56 Eyüp
Istanbul 34056 - Turkey
Tel:+90 212 565 24 00
Fax: +90 212 565 44 00
info@osg-turkey.com

ROMSAN INTERNATIONAL CO. SRL

Reprezentant Exclusiv OSG
25C, Bucuresti-Magurele Street
051431 Bucuresti - România
Tel: +40 21 322 07 47
Fax: +40 21 321 56 00
romsan.int@romsan.ro

AUSTRIA

Branch office of OSG GERMANY
Messestraße 11
A-6850 Dornbirn
Tel: +49 7161 6064-0
Fax: +49 7161 6064-444
info@osg-germany.de

OSG ITALIA

Via Ferrero, 65 A/B3
I - 10098 Rivoli - Italy
Tel: +39 0117705211
Fax: +39 0117705215
info@osg-italia.it

Vischer & Bolli AG

Machining and Workholding
Im Schossacher 17
CH-8600 Dübendorf
T +41 44 802 15 15
F +41 44 802 15 95
info@vb-tools.com



OSG Group Company

04/2022 - All rights reserved. © OSG Europe 2022

The contents of this catalogue are provided to you for viewing only. They are not intended for reproduction either in part or in whole in this or other medium. They cannot be copied, used to create derivation work or used for any reason, by means without the express, written permission of the copyright owner. If prices are stated, they are netto unit-prices and any eventual tax(es) have to be added. The company is not responsible for any printing error in technical, price and/or any other data.

Tool specifications subject to change without notice.

www.osgeurope.com